

KELOX

KM258 KELOX stopper for pressure testing 40x1/2"

7604400

Areas of application

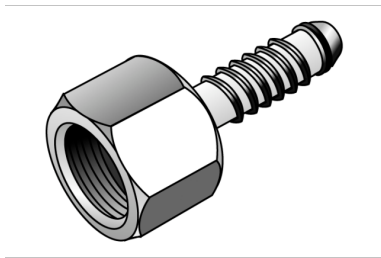

Re-usable plug for forcing off KELOX multilayer pipes

After removing the forcing-off plug, cut off the pipe end!

NOT suitable for continuous use!

Specifications

Technical properties

maximum working pressure at 20 ° C	10
------------------------------------	----

Product information

VPE1	2,00 SA1
VPE2	60,00 KT1
weight	0,180 KGM
text	KELOX stopper for pressure testing
INTRNR	74122000
main material group	KELOX
material group	KELOX accessories
code	KM258

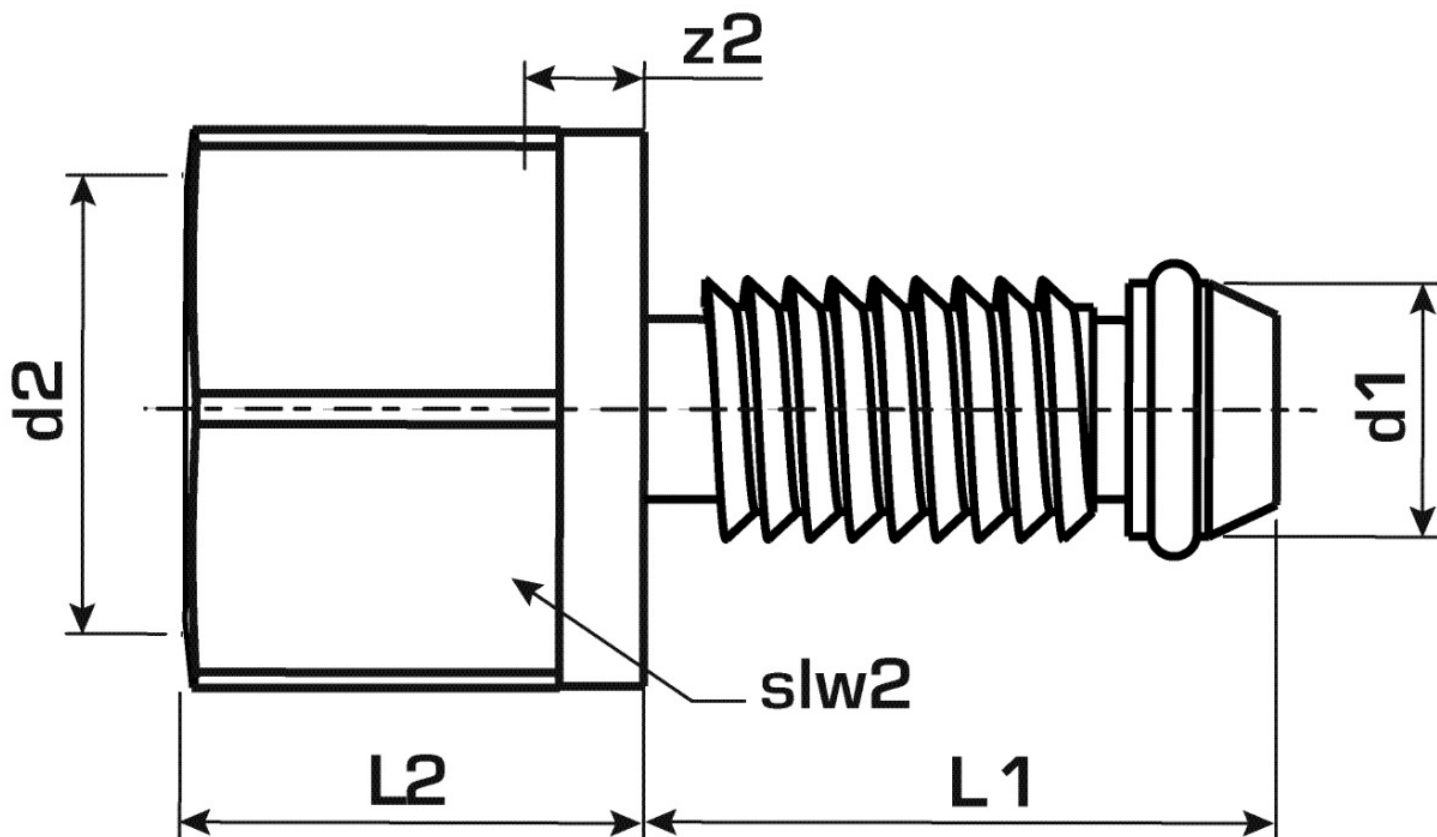

Art. No	label	d1 mm	L1 mm	L2 mm	z2 mm	slw2
7604400	40x1/2"	40	41	22	8	34