

KELOX

KMP460 KELOX-PROTEC elbow adapter 90° male 20x3/4"

73212D04

Areas of application

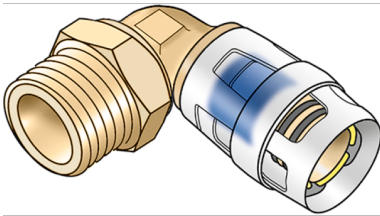

?Plug-in adapter elbow with male thread for sealing, made of dezincification-resistant brass (DZR), incl. push-on sleeve made of transparent polyamide, O-rings, withdrawal barriers and protector ring as an insertion locking device

Approvals:



KE KELIT GmbH

A 4020 Linz, Ignaz-Mayer-Straße 17, Austria, Europe

PHONE +43 (0) 50 779 E-MAIL office@kekelit.com

www.kekelit.com

Specifications

Article information

port 1	Plug-in
port 2	Male thread conical (NPT) conical (NPT)
design	Knee
angle	90 °

Technical properties

maximum working pressure at 20 ° C	10 bar
------------------------------------	--------

Product information

VPE1	10,00 SA1
VPE2	90,00 KT1
weight	0,142 KGM
text	KELOX-PROTEC elbow adapter 90° male
INTRNR	74122000
main material group	KELOX
material group	KELOX-PROtec pushfittings
code	KMP460

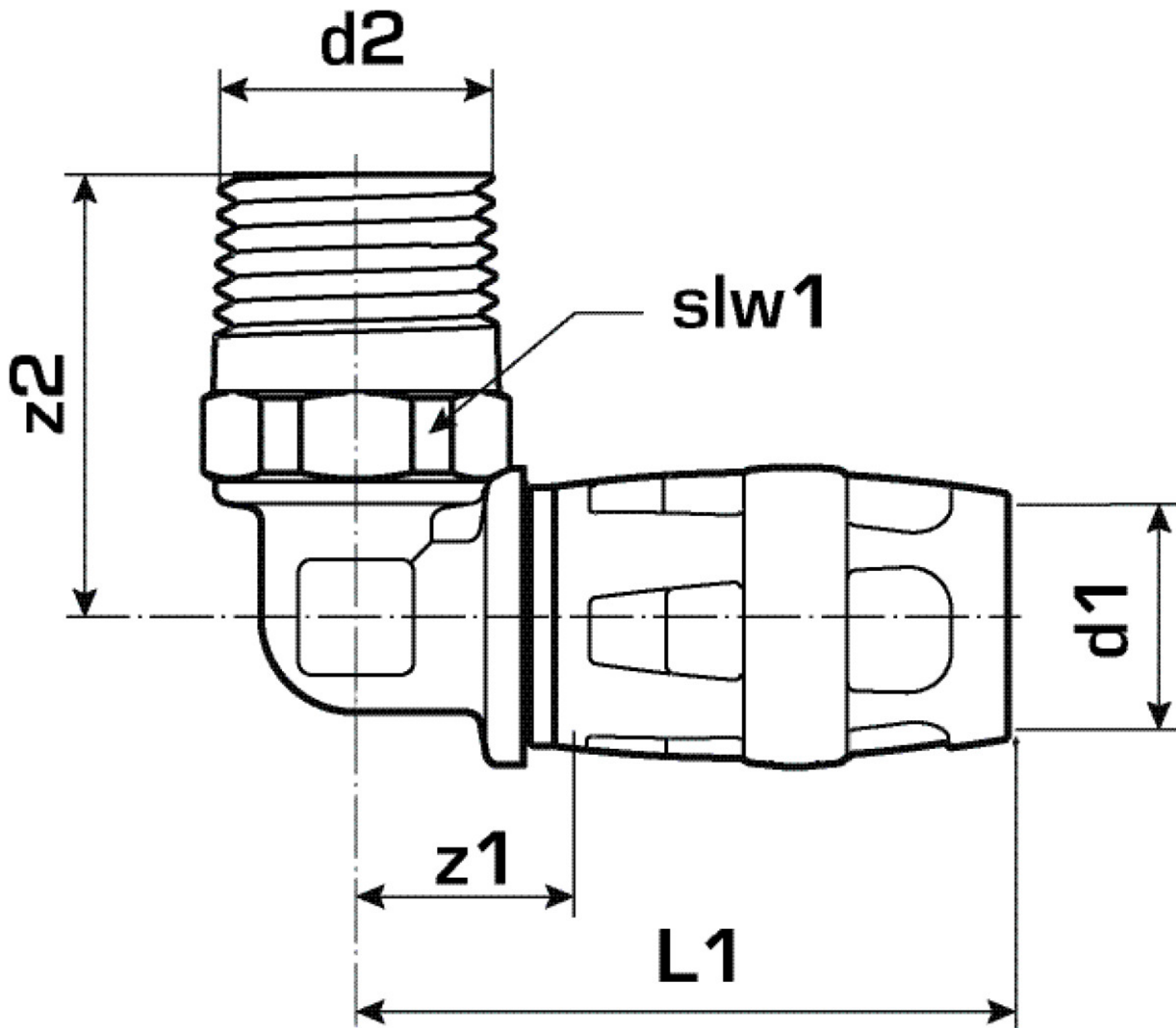

Art. No	label	d1 mm	L1 mm	L2 mm	z1 mm	slw1 mm
73212D04	20x3/4"	20	48,5	33,5	15,5	27