

STEELOX

SMX467 ?STEELOX 90° adapter elbow with female thread 20x1/2"

57216D02

Areas of application

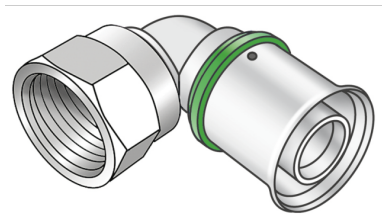

?Press-fit adapter elbow with female thread, made of non-porous metallised dezincification-resistant brass (DZR), incl. support sleeves with O-rings and stainless steel pressing sleeves, "leak before pressed"

DO NOT join threaded pipe or malleable iron fittings!

Approvals:



Specifications

Article information

port 1	Pressing socket
port 2	Innengewinde zylindrisch BSPT-Rp (ISO 7-1 / EN 10226-1)
execution	1-part
design	Knee
angle	90 °
press contour	SX

Technical properties

maximum working pressure at 20 ° C	10 bar
------------------------------------	--------

Product information

VPE1	10,00 SA1
VPE2	160,00 KT1
weight	0,082 KGM
text	?STEELOX 90° adapter elbow with female thread
INTRNR	74122000
code	SMX467

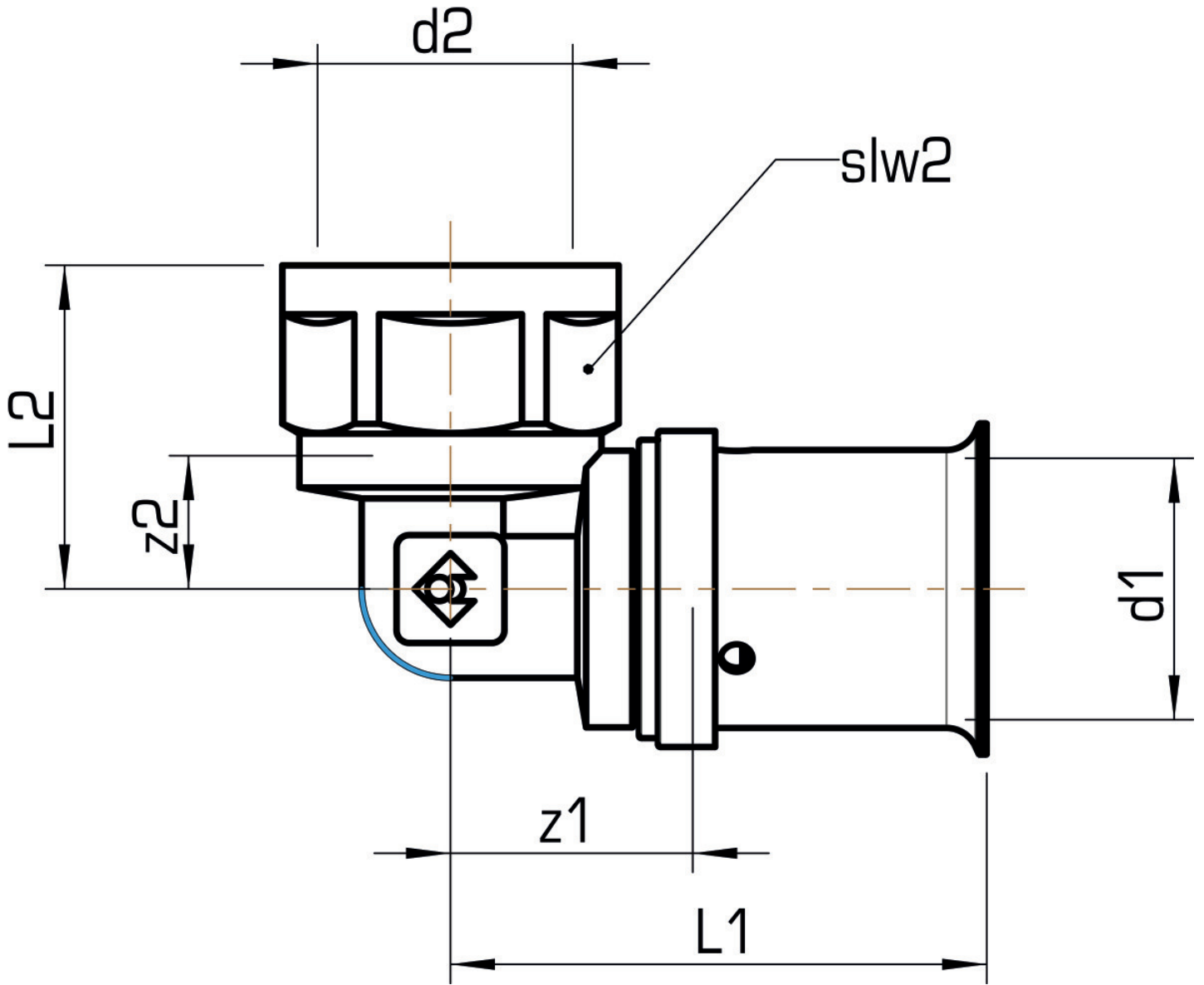

Art. No	label	d2 Inches	d1 mm	L1 mm	L2 mm	z1 mm	z2 mm	slw1 mm	slw2 mm
57216D02	20x1/2"	1/2" (15)	20	56	29	30,5	29	24	24