

# STEEL FIX EDELSTAHL

NP451 Stainless steel press union with male thread 22x3/4"

53741D04

## Areas of application

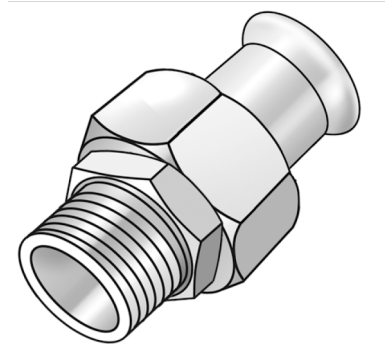

Press-fit union with male thread conforming to EN 10226-1 made of stainless steel 1.4404, incl. EPDM sealing components, d15-54 "leak before pressed"

Press contour: M

## Approvals:



# Specifications

## Article information

port 1	Pressmuffe
port 2	Außengewinde konisch (NPT)
execution	1-teilig
design	gerade
press contour	M

## Product information

VPE1	2 SA1
VPE2	40 KT1
VPE3	1000 DDP
weight	0,252 KGM
text	Stainless steel press union with male thread
INTRNR	73072980
main material group	STEELFIX
material group	EDELSTAHL pressfittings
code	NP451

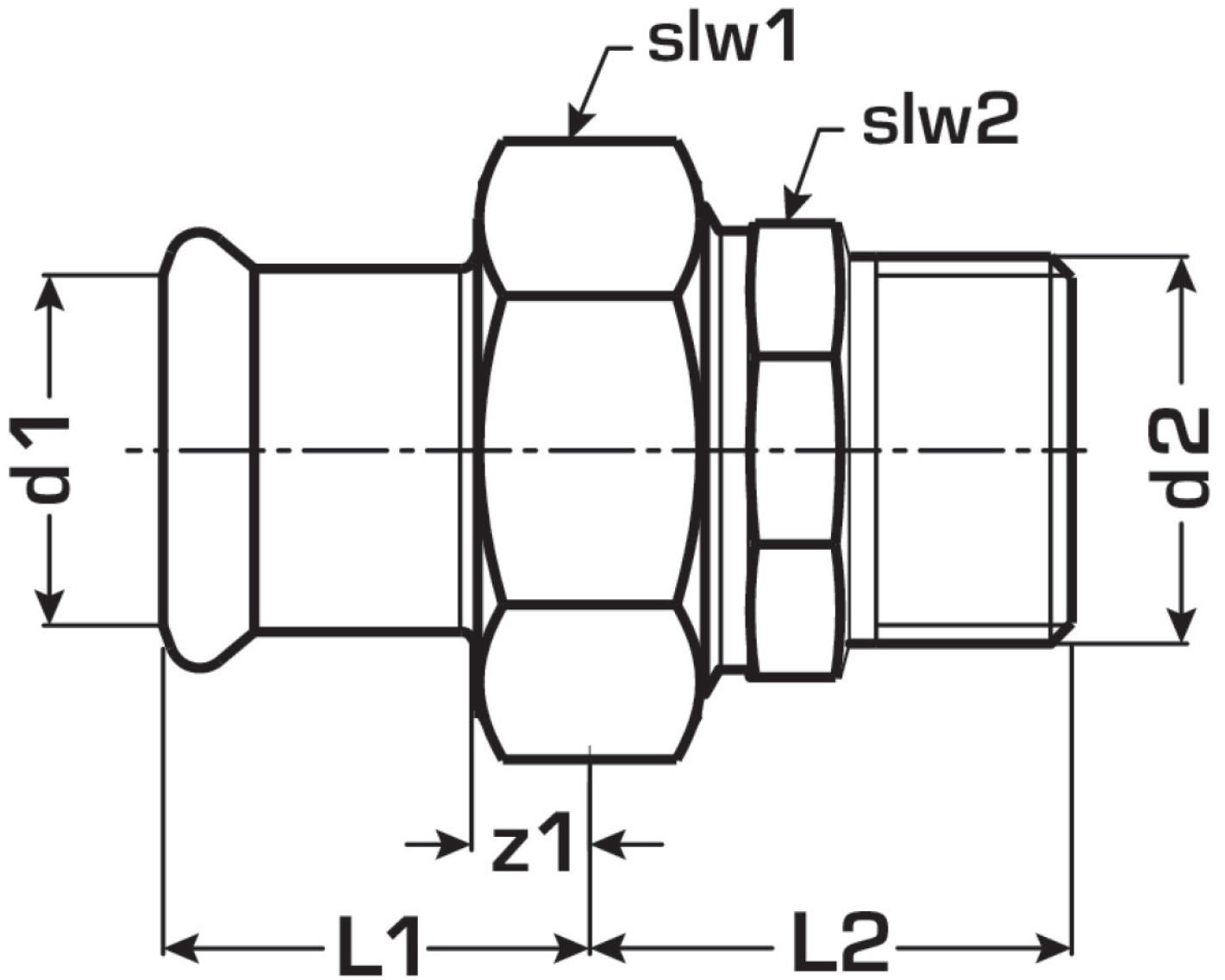

Art. No	label	d2	d1 mm	L1 mm	L2 mm	z1 mm	slw1 mm	slw2 mm
53741D04	22x3/4"	3/4 Zoll (20)	22	69	29	9	37	32