

# KETRIX

## TRI11 KETRIX adapter with male thread 20x3/4"

55210D04

### Areas of application

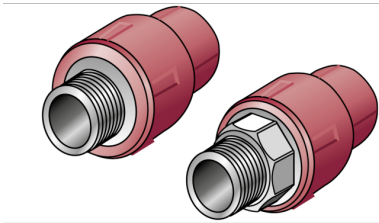

KETRIX polyfusion weld fitting for connecting POB pipes with fittings made of the same material without narrowing the cross-section, with injected male thread made of dezincification-resistant brass and non-porous metal plating, thread conforms to ÖNORM EN 10226

System parts marked with an "S" are produced with a wrench attachment connection

# Specifications

Product information	
VPE1	10,00 SA1
VPE2	50,00 KT1
VPE3	200,00 KT2
VPE4	4800,00 PAL
weight	0,145 KGM
text	KETRIX adapter with male thread
INTRNR	39174000
main material group	KETRIX
material group	KETRIX metal fittings
code	TRI11

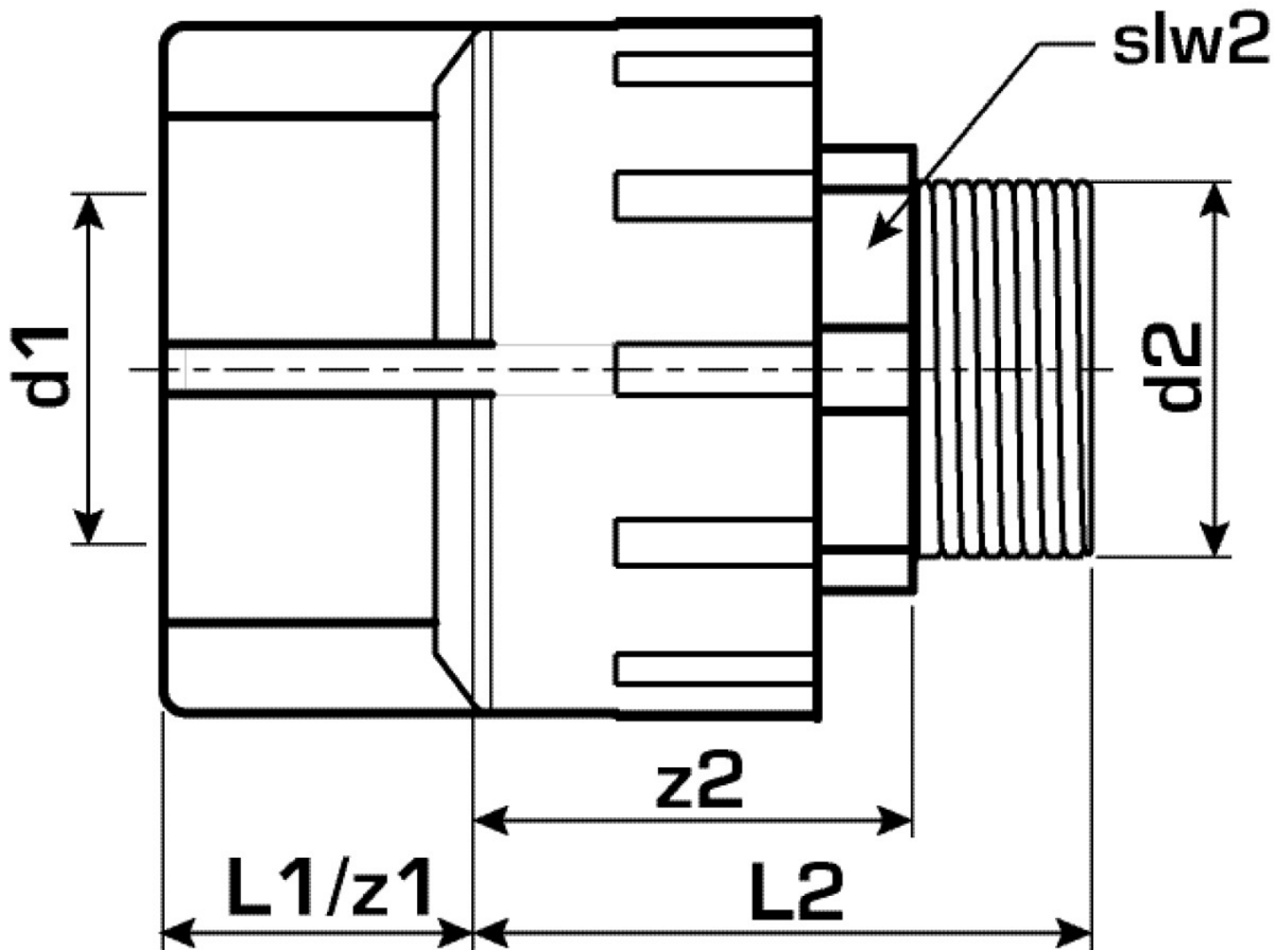

Art. No	label
55210D04	20x3/4"