

# LEXEL

## LX60 LEXEL insertion guide cap 23-25

5800045

### Areas of application

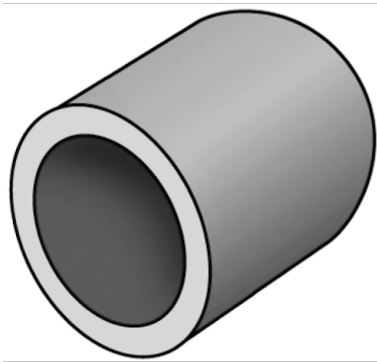

To insert at the pipe ends, as insertion aid

# Specifications

## Product information

<b>VPE1</b>	10,00 SA1
<b>weight</b>	0,004 KGM
<b>text</b>	LEXEL insertion guide cap
<b>INTRNR</b>	39259080
<b>main material group</b>	LEXEL
<b>material group</b>	LEXEL isolation and accessories
<b>code</b>	LX60



Art. No	label
5800045	23-25



**KE KELIT GmbH**

A 4020 Linz, Ignaz-Mayer-Straße 17, Austria, Europe

**PHONE** +43 (0) 50 779 **E-MAIL** [office@kekelit.com](mailto:office@kekelit.com)

[www.kekelit.com](http://www.kekelit.com)