

# KELIT PEX

## PEX19S-K KELIT PEX tee piece clamping connection SANITARY 32/25/32

302090350001K

### Areas of application

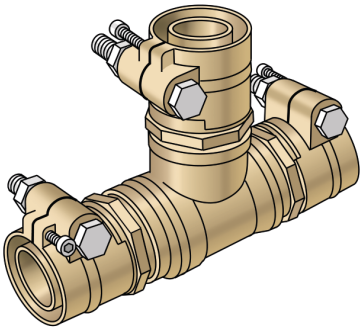

PEX tee clamping connection made of brass, for connecting PEX05 or PEX06 sanitary pipes (SDR 7.4)

# Specifications

## Product information

<b>VPE1</b>	1,00 STK
<b>weight</b>	1,350 KGM
<b>text</b>	KELIT PEX tee piece clamping connection SANITARY
<b>INTRNR</b>	74122000
<b>main material group</b>	KELIT PEX
<b>material group</b>	PEX sanitary-fittings
<b>code</b>	PEX19S-K

## Art. No

302090350001K

## label

32/25/32



**KE KELIT GmbH**

A 4020 Linz, Ignaz-Mayer-Straße 17, Austria, Europe

**PHONE** +43 (0) 50 779 **E-MAIL** office@kekelit.com

www.kekelit.com