

# KELIT PEX

## PEX19S-K KELIT PEX tee piece clamping connection SANITARY 40/25/40

302090600001K

### Areas of application

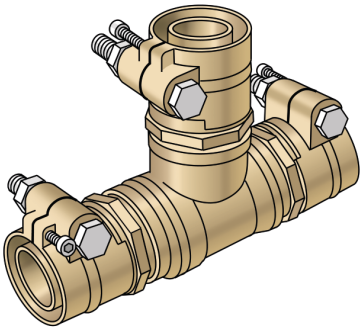

PEX tee clamping connection made of brass, for connecting PEX05 or PEX06 sanitary pipes (SDR 7.4)

# Specifications

Product information	
VPE1	1,00 STK
weight	2,000 KGM
text	KELIT PEX tee piece clamping connection SANITARY
INTRNR	74122000
main material group	KELIT PEX
material group	PEX sanitary-fittings
code	PEX19S-K

Art. No	label
302090600001K	40/25/40



**KE KELIT GmbH**

A 4020 Linz, Ignaz-Mayer-Straße 17, Austria, Europe

PHONE +43 (0) 50 779 E-MAIL [office@kekelit.com](mailto:office@kekelit.com)

[www.kekelit.com](http://www.kekelit.com)