

KELIT PEX

PEX11-K KELIT PEX-PEX clamping connection 75x6.8/75x6.8

303045100010

Areas of application

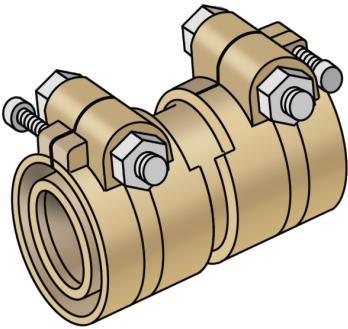

PEX / PEX clamping connection made of brass, for connecting PEX00, PEX03, PEX09 or PEX10 pipes (SDR 11)

Specifications

Product information

VPE1	1,00 STK
weight	2,000 KGM
text	KELIT PEX-PEX clamping connection
INTRNR	74122000
main material group	KELIT PEX
material group	PEX fittings and accessories
code	PEX11-K

Art. No

label

303045100010

75x6.8/75x6.8



KE KELIT GmbH

A 4020 Linz, Ignaz-Mayer-Straße 17, Austria, Europe

PHONE +43 (0) 50 779 **E-MAIL** office@kekelit.com

www.kekelit.com