

KELIT PEX

PEX15-K KELIT PEX clamping connection with male thread 63x5.8mm / 2"

303018120

Areas of application

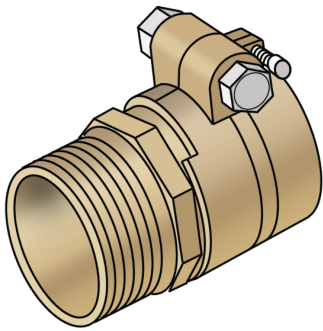

Steel / PEX clamping connection made from brass, adapter with male thread according to ÖNORM EN 10226, for connecting PEX00, PEX03, PEX09 or PEX10 pipes (SDR 11).

Stainless steel version available on request.

Specifications

Product information	
VPE1	1,00 STK
weight	1,100 KGM
text	KELIT PEX clamping connection with male thread
INTRNR	74122000
main material group	KELIT PEX
material group	PEX fittings and accessories
code	PEX15-K

Art. No	label
303018120	63x5.8mm / 2"