

KELIT PEX

PEX61 KELIT DUO-PEX end cap heat shrink 75+75

3031370

Areas of application

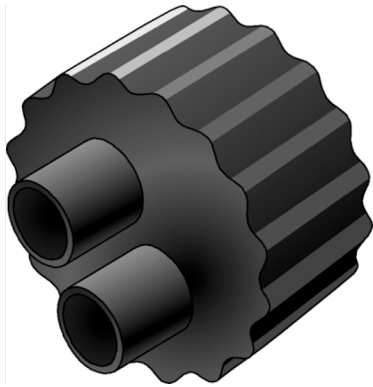

PE-HD heat shrinking DUO end cap, for watertight insulating seals in ducts or buildings

Specifications

Product information	
casing DA	202
VPE1	1,00 STK
weight	0,230 KGM
text	KELIT DUO-PEX end cap heat shrink
INTRNR	39174000
main material group	KELIT PEX
material group	PEX sleeves and accessories
code	PEX61

Art. No	label
3031370	75+75