

KE02 KELEN PP-RCT pipe - PN10 315x28.6

1731500

Areas of application

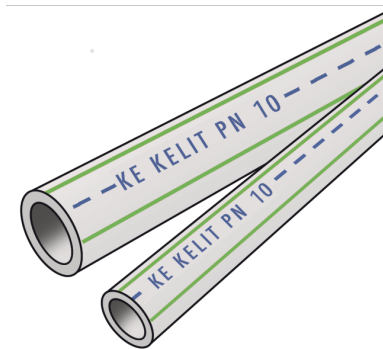

KELEN PP-RCT drinking water pipe system conforming to ÖNORM EN ISO 15874 made of polypropylene (PP-RCT)

Application area: 20°C/10 bar

Colour: grey with 3 co-extruded green longitudinal lines

Length: 4m

Approvals:



KE KELIT GmbH

A 4020 Linz, Ignaz-Mayer-Straße 17, Austria, Europe

PHONE +43 (0) 50 779 E-MAIL office@kekelit.com

www.kekelit.com

Specifications

Article information

port 1 Rohrende

port 2 Rohrende

Technical properties

PN PN 10

Product information

DIM2 257,8

VPE1 5,00 BND

L 5 m

weight 24,600 KGM

text KELEN PP-RCT pipe - PN10

INTRNR 39172290

main material group KELEN

material group KELEN pipes

code KE02

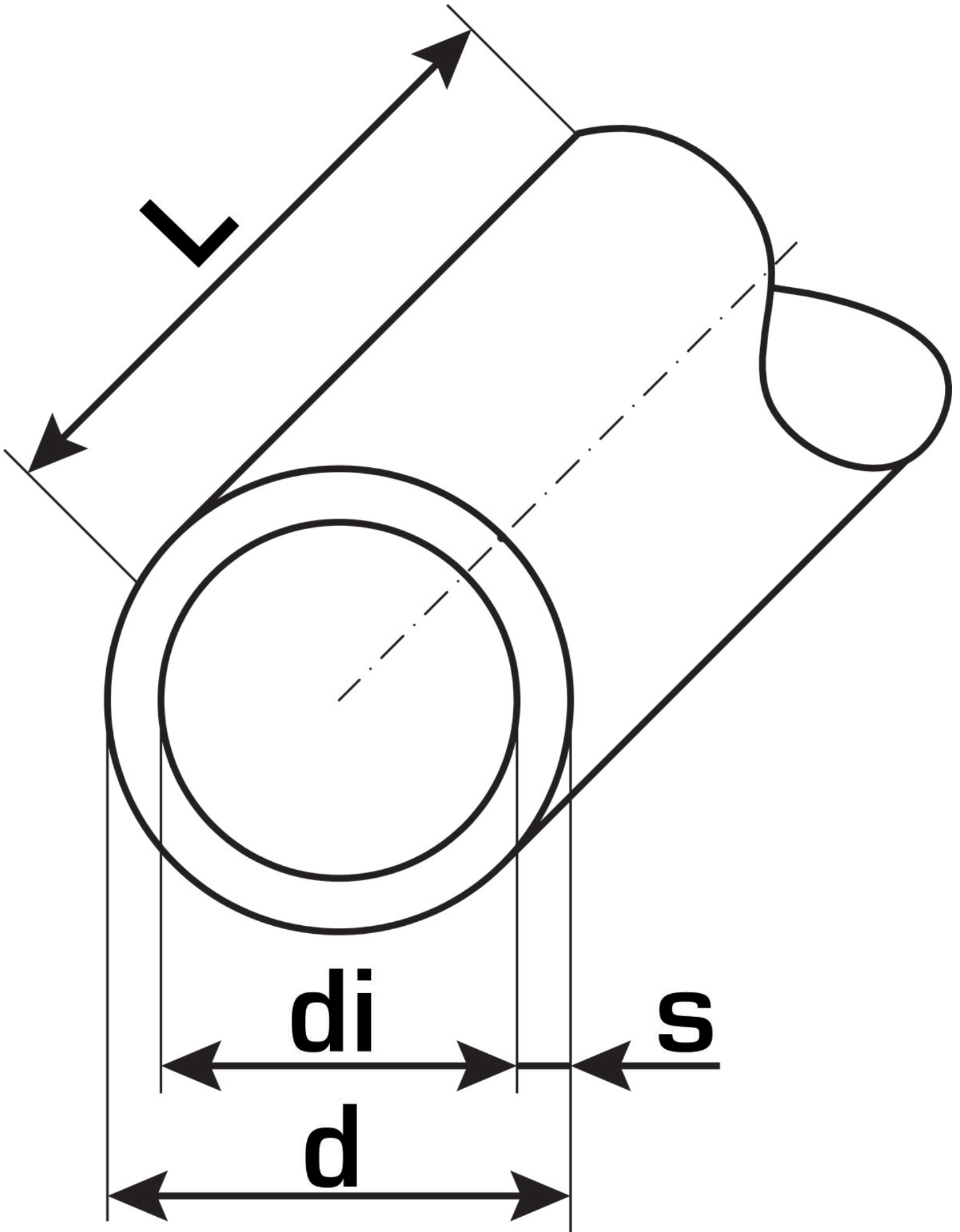

Art. No	label
1731500	315x28.6



KE KELIT GmbH
A 4020 Linz, Ignaz-Mayer-Straße 17, Austria, Europe
PHONE +43 (0) 50 779 **E-MAIL** office@kekelit.com
www.kekelit.com