

KE35ST KELEN reducer tee - PN10 125/90

2780402

Areas of application

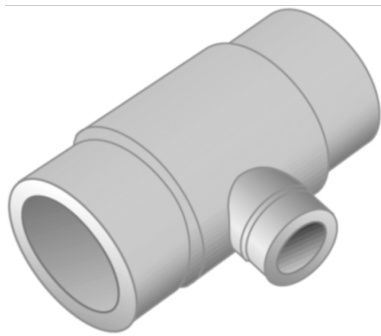

KELEN butt welding fitting for connecting pipes to fittings made of the same material

Approvals:



Specifications

Article information

port 1	Zapfen/Rohrende
port 2	Zapfen/Rohrende
port 3	Kunststoffschweißmuffe
execution	T-Stück
angle	90 °

Technical properties

maximum working pressure at 20 ° C	10 bar
------------------------------------	--------

Product information

VPE1	1,00 SA1
weight	1,640 KGM
text	KELEN reducer tee - PN10
INTRNR	39174000
main material group	KELEN
material group	KELEN plastic fittings
code	KE35ST

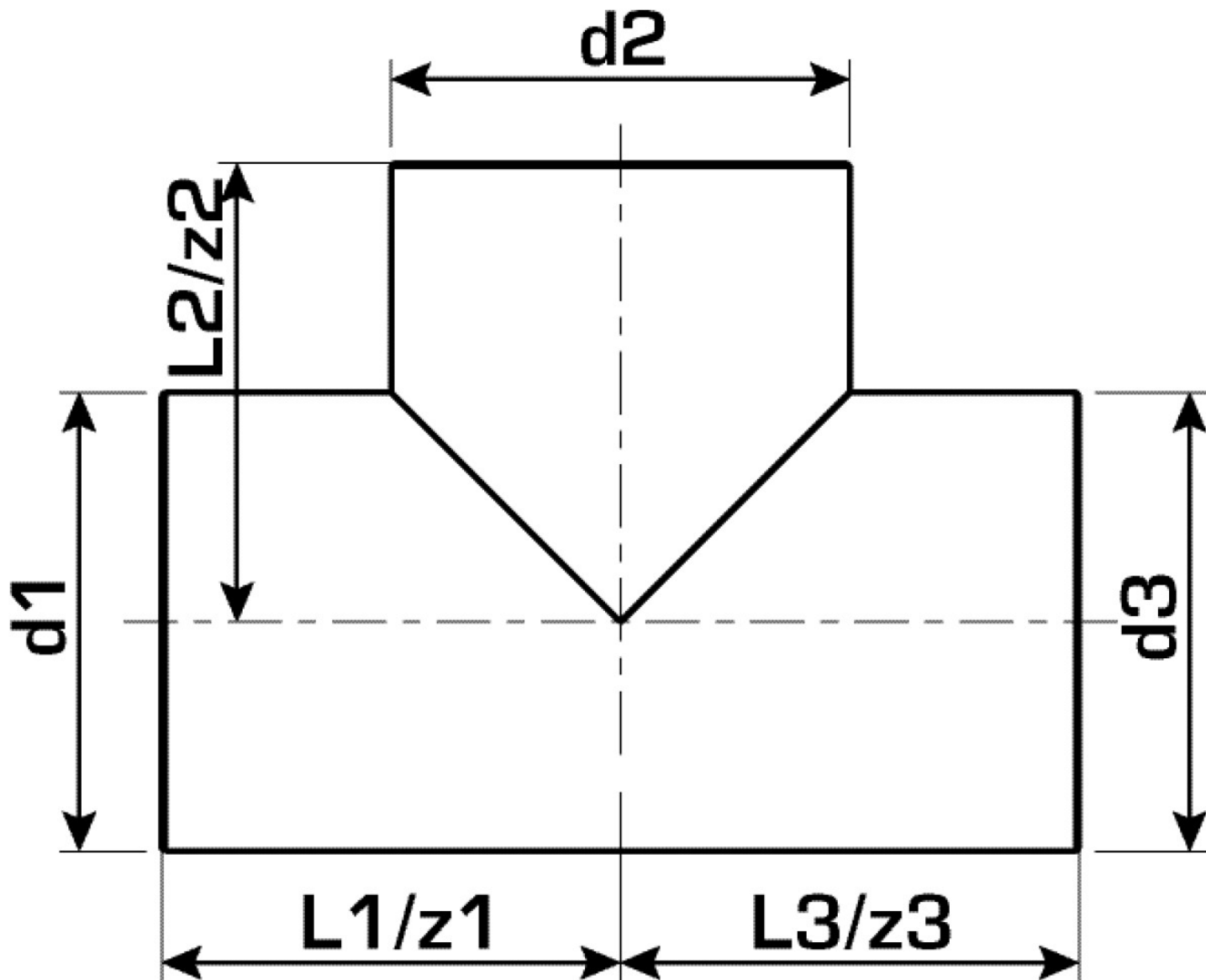

Art. No	label	d1 mm	d2 mm	d3 mm	L1 mm	L2 mm	L3 mm	z1 mm	z2 mm	z3 mm
2780402	125/90	125	90	125	170	170	170	170	170	170