

K50C KELIT shut-off valve stem 3/4" w/out visible parts

2660960

Areas of application

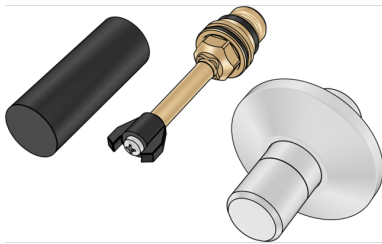

Shut-off valve, incl. chrome-plated end cap, rosette and protection cap, compatible with KE50A and KE50P.

Approvals:



Specifications

Product information

VPE1	1,00 SA1
weight	0,180 KGM
text	KELIT shut-off valve stem
INTRNR	84819000
main material group	KELEN
material group	KELEN accessories
code	K50C

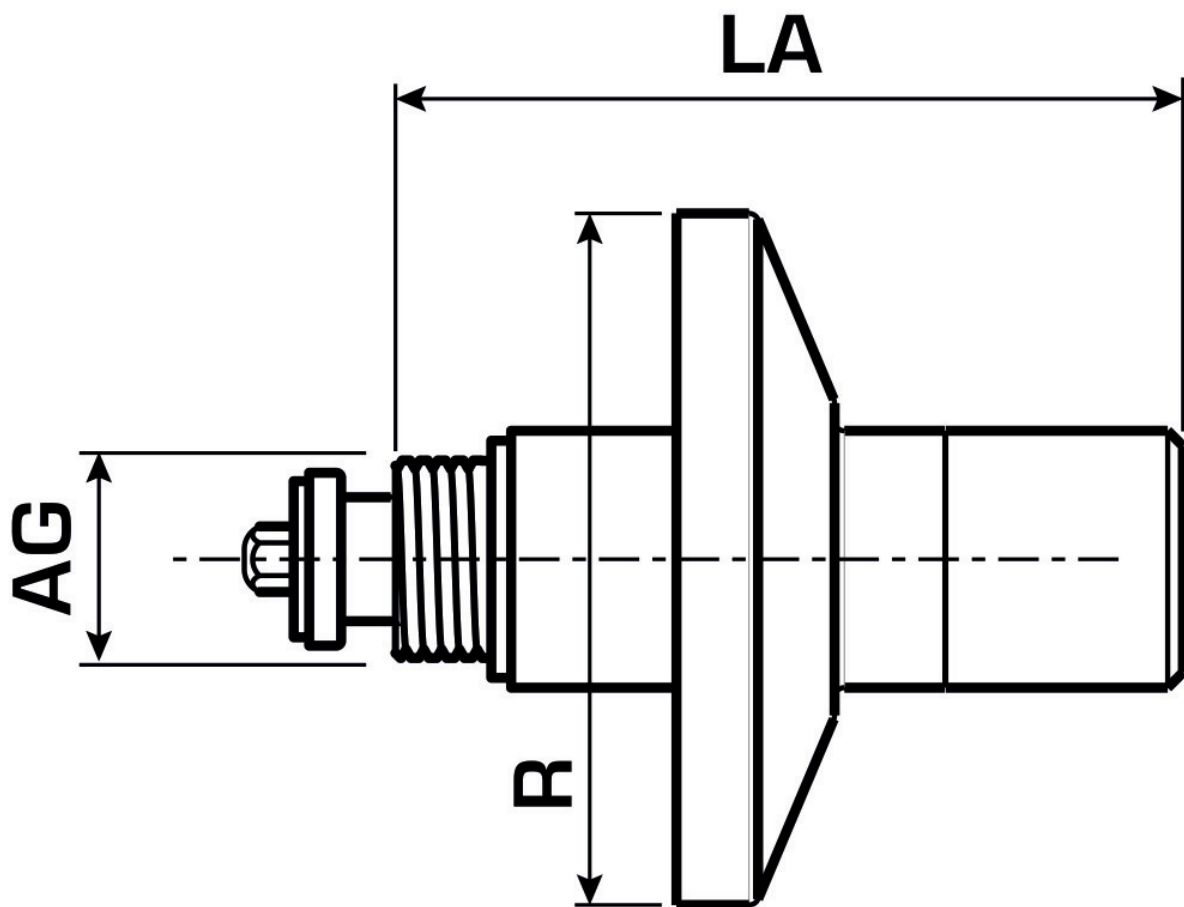

Art. No

label

2660960

3/4" w/out visible parts