

# KELEN PP-RCT

KE51P KELEN plastic-ball valve - PN6 - PN16 50

2669401

## Areas of application

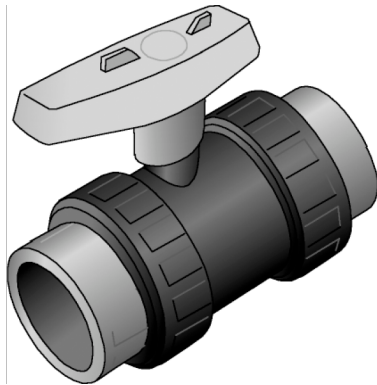

KELEN plastic ball valve with two detachable screw fittings for polyfusion welding connections with pipes (no reduction of internal diameter)

Pressure levels:

d20-d63 - PN16

d75-d90 - PN10

d110 - PN6 - ONLY cold water

Plastic sockets are available separately!

ATTENTION, NOT suitable for freezing temperatures - valve body made of PVC!

ATTENTION: DO NOT use for compressed air, please use commercially available compressed air fittings!

## Approvals:



# Specifications

Product information	
VPE1	1,00 SA1
VPE2	5,00 KT1
VPE3	30,00 KT2
VPE4	480,00 PAL
weight	1,120 KGM
text	KELEN plastic-ball valve - PN6 - PN16
INTRNR	39174000
main material group	KELEN
material group	KELEN metal fittings
code	KE51P

Art. No	label
2669401	50