

# STEEL FIX C-STAHl

CP458 STEELFIX carbon steel press-fit sliding sleeve with female thread 22x1/2"

54707D02

## Areas of application

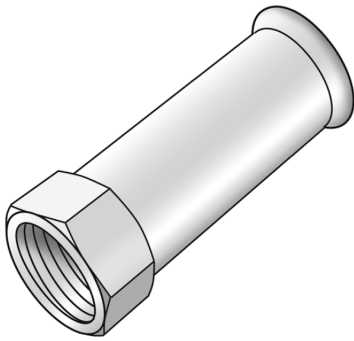

Press-fit sliding sleeve adapter with female thread made of carbon steel coated with a zinc layer, incl. EPDM sealing elements, "leak before pressed"

Press contour: M

# Specifications

## Article information

port 1	Pressmuffe
port 2	Innengewinde zylindrisch BSPT-Rp (ISO 7-1 / EN 10226-1)
execution	1-part
design	gerade
press contour	M

## Product information

VPE1	10,00 SA1
VPE2	60,00 KT1
VPE3	1500,00 DDP
weight	0,115 KGM
text	STEELFIX carbon steel press-fit sliding sleeve with female thread
INTRNR	73079980
main material group	STEELFIX
material group	C-STAHL pressfittings
code	CP458

Art. No	label
54707D02	22x1/2"