

KELOX_{FB}

KM570F KELOX manifold cabinet body 110
Special size L: 1050mm

9000711

Areas of application

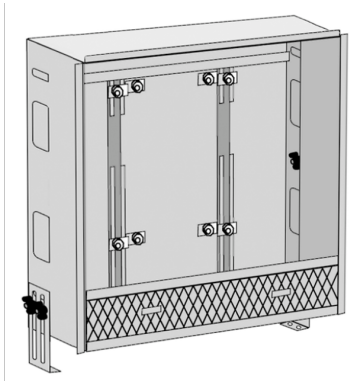

?Sendzimir-galvanised sheet metal cabinet can be connected from below or at the side; height-adjustable feet; surface-or flush-mounted visible part can be retrofitted. Suitable for installing the KM651 KELOX FB fixed value regulator set. Space for straight or 90° connection sets KM593E as well as KM591E 90° elbow taken into account. Number of manifold outlets matched to KM590E and KMP590M KELOX FB manifold, brass!

Plaster trim element below cabinet, Width: 120mm

Cabinet depth: 110mm

Installation height: 600mm above finished floor

Specifications

Product information		
VPE1		1,00 KT1
weight		11,050 KGM
text		KELOX manifold cabinet body 110
INTRNR		84818099
code		KM570F

Art. No	label	t mm
9000711	Special size L: 1050mm	110