

KELOX

KMP455X KELOX-PROTEC CLIX screw fitting with female thread 16x3/4"

730203B04

Areas of application

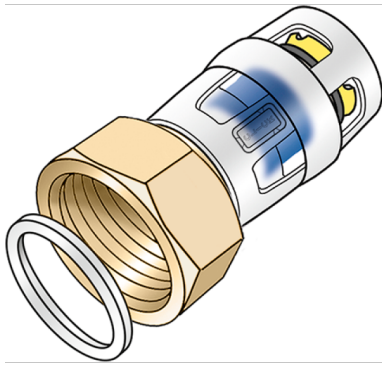

Plug-in screw fitting with female thread for connecting to fittings, e.g. filters, manifolds, pumps,..... made of dezincification-resistant brass (DZR), incl. support sleeves with insertion click noise, as well as haptic and optical insertion indicator, O-rings, withdrawal barriers and protector ring as insertion locking device, flat-sealing incl. seal

Approvals:



Specifications

Article information

port 1	Plug-in
port 2	Female thread cylindrical BSPT-Rp (ISO 7-1)
design	Straight

Technical properties

maximum working pressure at 20 ° C	10 bar
------------------------------------	--------

Product information

VPE1	10,00 SA1
VPE2	200,00 KT1
weight	0,074 KGM
text	KELOX-PROTEC CLIX screw fitting with female thread
INTRNR	74122000
main material group	KELOX
material group	KELOX-PROtec pushfittings
code	KMP455X



Art. No	label	d2	d1 mm	L1 mm	L2 mm	z1 mm	z2 mm	slw1	slw2 mm
730203B04	16x3/4"	3/4" (20)	16	36	23	4	14,5	30	30