

KELOX

KWP450X KELOX-PROTEC CLIX PPSU adapter with male thread 20x3/4"

730702D04

Areas of application

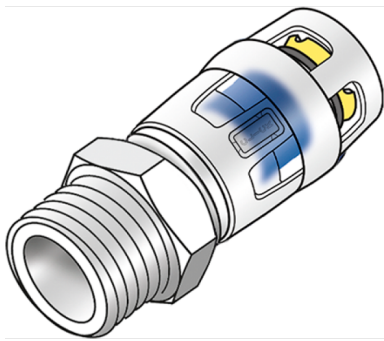

Plug-in adapter with male thread for sealing with hemp, made of PPSU, including support sleeves with insertion click noise, as well as haptic and optical insertion indicator, O-rings, withdrawal barriers and protector ring as insertion locking device

DO NOT use liquid sealants or thread sealing tape!

Approvals:



Specifications

Article information

port 1	Plug-in
execution	Miscellaneous
design	Straight

Technical properties

maximum working pressure at 20 ° C	10 bar
------------------------------------	--------

Product information

VPE1	10,00 SA1
VPE2	130,00 KT1
weight	0,028 KGM
text	KELOX-PROTEC CLIX PPSU adapter with male thread
INTRNR	39174000
main material group	KELOX
material group	KELOX-PROtec-PPSU pushfittings
code	KWP450X

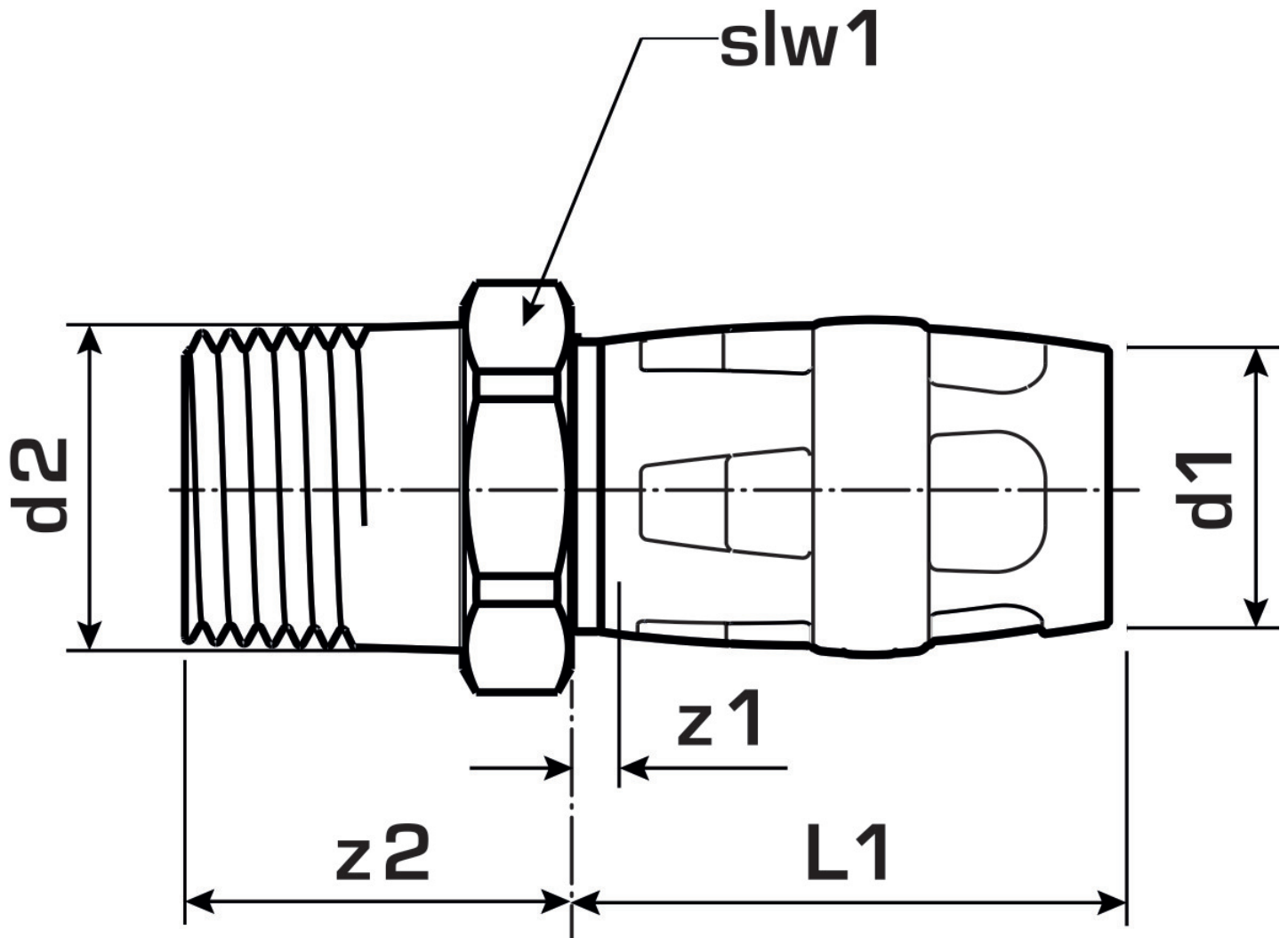

Art. No	label	d2 Inches	d1 mm	L1 mm	z1 mm	z2 mm	slw1 mm
730702D04	20x3/4"	3/4" (20)	20	33	3	33	30