

KELIT PEX

PEX61 KELIT DUO-PEX end cap heat shrink 90+90

3031400

Areas of application

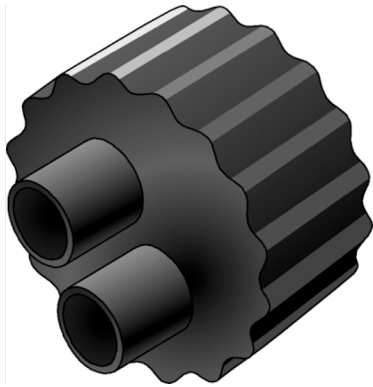

PE-HD heat shrinking DUO end cap, for watertight insulating seals in ducts or buildings

Specifications

Product information

casing DA	225
VPE1	1,00 STK
weight	0,500 KGM
text	KELIT DUO-PEX end cap heat shrink
INTRNR	39174000
main material group	KELIT PEX
material group	PEX sleeves and accessories
code	PEX61

Art. No	label
3031400	90+90



KE KELIT GmbH

A 4020 Linz, Ignaz-Mayer-Straße 17, Austria, Europe

PHONE +43 (0) 50 779 **E-MAIL** office@kekelit.com

www.kekelit.com