

KELOX

KMP485HKX KELOX-PROTEC CLIX connection set for radiators 16x1/2" 5 or 8cm

730267B02

Areas of application

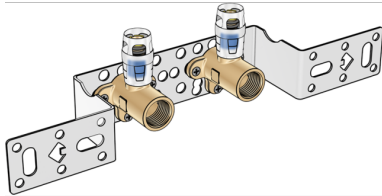

With KMP480X wall bracket fitting, sound-insulated
DO NOT screw in any threaded pipes and cast iron fittings!

Approvals:



Specifications

Product information	
VPE1	1,00 KT1
VPE2	15,00 KT2
weight	0,429 KGM
text	KELOX-PROTEC CLIX connection set for radiators
INTRNR	74122000
main material group	KELOX
material group	KELOX-PROtec pushfittings
code	KMP485HKX

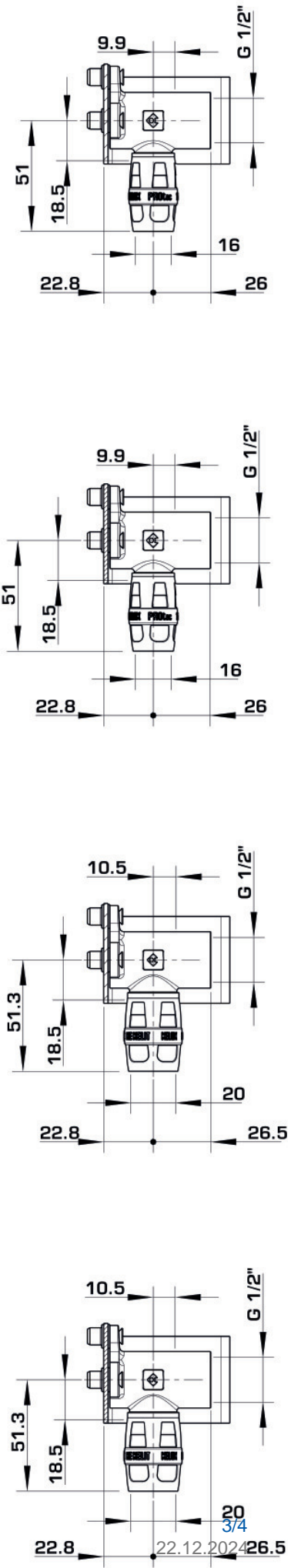
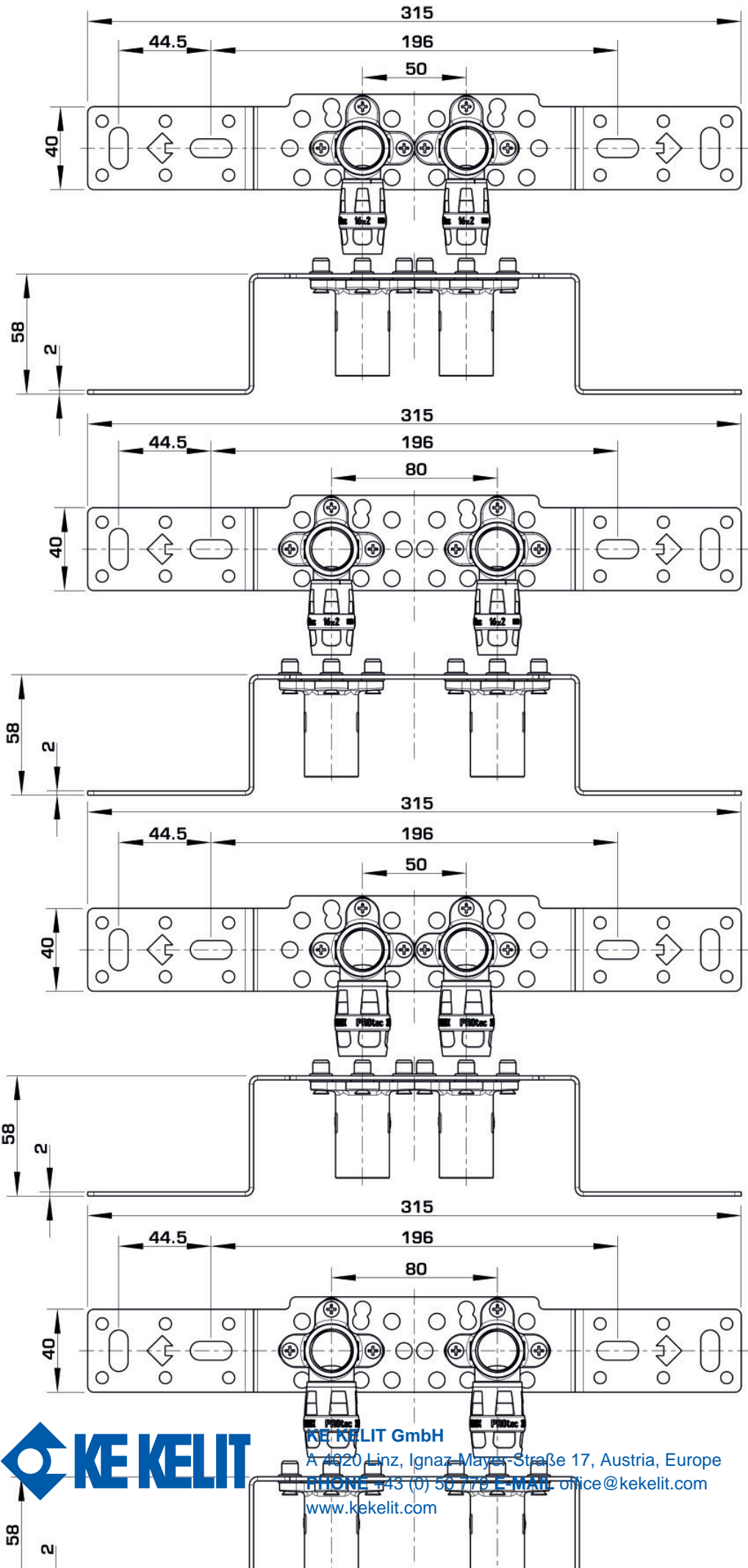

KEKELIT GmbH
 A 4020 Linz, Ignaz Mayer-Straße 17, Austria, Europe
 PHONE +43 (0) 50 770 E-MAIL office@kekelit.com
 www.kekelit.com

20
 3/4

22.12.2024 26.5

Art. No	label
730267B02	16x1/2" 5 or 8cm



KE KELIT GmbH
A 4020 Linz, Ignaz-Mayer-Straße 17, Austria, Europe
PHONE +43 (0) 50 779 **E-MAIL** office@kekelit.com
www.kekelit.com