

KE1008 KELEN-PP-RCT CX pipe - PN16 40x5.5

30040005

Areas of application

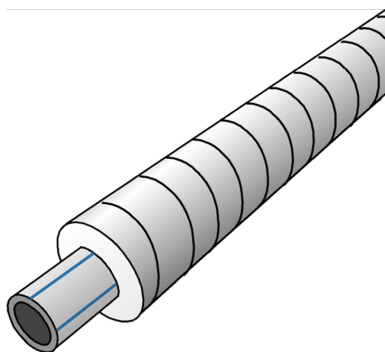

Pre-insulated drinking water pipe system based on ÖNORM EN ISO 15874

Medium pipe: KELEN made of polypropylene copolymer (PP-R), adhesion-pretreated

Application area: 20°C/16 bar - 60°C/8 bar

Insulation: PUR rigid foam

Jacket pipe: 0.6 mm galvanised folded spiral sheet metal

Length: 6m

Approvals:



Specifications

Product information	
casing DA	80
VPE1	6,00 STG
L	6 m
weight	2,260 KGM
text	KELEN-PP-RCT CX pipe - PN16
INTRNR	39172290
main material group	KELEN CX/PE
material group	KELEN CX/PE pipes and fittings
code	KE1008

Art. No	label
30040005	40x5.5