

# KELOX

## KM110 ?KELOX multilayer pipe 40x4 /5m

7410400

### Areas of application

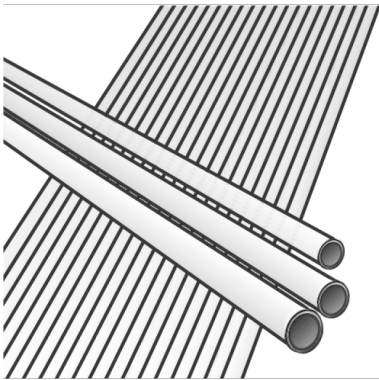

?KELOX multilayer pipe conforming to ÖNORM EN ISO 21003, oxygen-and water vapour diffusion-tight 5-layer PE-RT/Al/PE-RT composite pipe

Operating conditions classified acc. to ÖNORM EN ISO 21003

Sanitary application - Class 2: 70°C - tmax 80°C/10 bar

Radiator connection - Class 5: 80°C - tmax 90°C/10 bar

Colour: white/transparent

Rod length: 5m

## Approvals:



# Specifications

## Article information

**color** White

**flexible** 1

## Technical properties

**maximum working pressure at 20 ° C** 10 bar

**pipe weight** 0,55 kg/m

**pipe contents** 0,804 l/m

**lambda pipe** 0,45 W/(m.K)

**wall rawness** 0,007 mm

**expansion coefficient** 0,025 mm/(m.K)

## Product information

**VPE1** 20,00 BND

**VPE2** 2000,00 HOB

**L** 5 m

**weight** 0,572 KGM

**text** ?KELOX multilayer pipe

**INTRNR** 39173900

**main material group** KELOX

**material group** KELOX pipes

**code** KM110



| Art. No | label    | d1 mm | pipe contents l/m | s mm |
|---------|----------|-------|-------------------|------|
| 7410400 | 40x4 /5m | 40    | 0,804             | 4    |



**KE KELIT GmbH**

A 4020 Linz, Ignaz-Mayer-Straße 17, Austria, Europe

**PHONE** +43 (0) 50 779 **E-MAIL** office@kekelit.com

www.kekelit.com