

KELOX

KM110 ?KELOX multilayer pipe 63x6 /5m

7410630

Areas of application

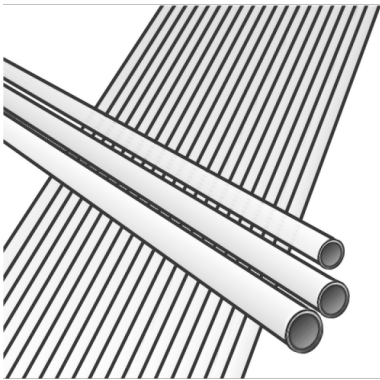

?KELOX multilayer pipe conforming to ÖNORM EN ISO 21003, oxygen-and water vapour diffusion-tight 5-layer PE-RT/Al/PE-RT composite pipe

Operating conditions classified acc. to ÖNORM EN ISO 21003

Sanitary application - Class 2: 70°C - tmax 80°C/10 bar

Radiator connection - Class 5: 80°C - tmax 90°C/10 bar

Colour: white/transparent

Rod length: 5m

Approvals:



Specifications

Article information

color White

flexible 1

Technical properties

maximum working pressure at 20 ° C 10 bar

pipe weight 1,25 kg/m

pipe contents 2,043 l/m

lambda pipe 0,45 W/(m.K)

wall rawness 0,007 mm

expansion coefficient 0,025 mm/(m.K)

Product information

VPE1 15,00 BND

VPE2 420,00 HOB

L 5 m

weight 1,284 KGM

text ?KELOX multilayer pipe

INTRNR 39173900

main material group KELOX

material group KELOX pipes

code KM110



Art. No	label	d1 mm	pipe contents l/m	s mm
7410630	63x6 /5m	63	2,043	6



KE KELIT GmbH

A 4020 Linz, Ignaz-Mayer-Straße 17, Austria, Europe

PHONE +43 (0) 50 779 **E-MAIL** office@kekelit.com

www.kekelit.com