

# KELOX

## KM580E KELOX radiator & sanitary manifold 5 L: 275mm

7805500

### Areas of application

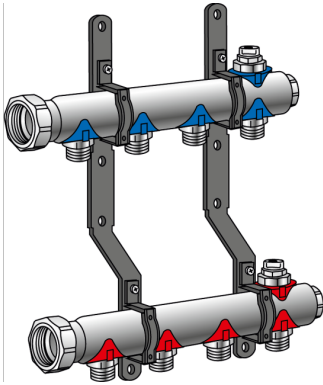

?Feed and return flow bars with heating circuit outlets 3/4" euro cone with male thread, with bleeding at the highest point and draining, manifold ends closed, connections with pre-formed union nut 1" flat-sealing, non-porous metallised brass, incl. labelled plates for each heating circuit and sound-insulated plastic consoles

Area of application: tmax. 90°C/10 bar

ATTENTION: WITHOUT KM220 Euro thread fitting!

## Approvals:



# Specifications

| Product information |                                    |
|---------------------|------------------------------------|
| VPE1                | 1,00 KT1                           |
| weight              | 1,969 KGM                          |
| text                | KELOX radiator & sanitary manifold |
| INTRNR              | 84818039                           |
| main material group | KELOX                              |
| material group      | KELOX accessories                  |
| code                | KM580E                             |

| Art. No | label      |
|---------|------------|
| 7805500 | 5 L: 275mm |