

KELOX

KM580E KELOX radiator & sanitary manifold 11 L: 575mm

7811500

Areas of application

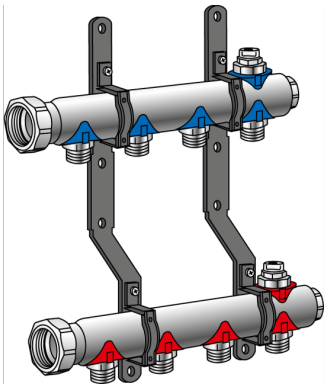

?Feed and return flow bars with heating circuit outlets 3/4" euro cone with male thread, with bleeding at the highest point and draining, manifold ends closed, connections with pre-formed union nut 1" flat-sealing, non-porous metallised brass, incl. labelled plates for each heating circuit and sound-insulated plastic consoles

Area of application: tmax. 90°C/10 bar

ATTENTION: WITHOUT KM220 Euro thread fitting!

Approvals:



Specifications

Product information	
VPE1	1,00 KT1
weight	3,612 KGM
text	KELOX radiator & sanitary manifold
INTRNR	84818039
main material group	KELOX
material group	KELOX accessories
code	KM580E

Art. No	label
7811500	11 L: 575mm