

KELOX

KMU460 KELOX-ULTRAX elbow adapter 90° male 20x3/4"

71212D04

Areas of application



Press adapter elbow with male thread for sealing, made of non-porous metallised brass, incl. support sleeves with O-rings and stainless steel press-fit sleeves, "leak before pressed"

Approvals:



Specifications

Article information

port 1	Pressing socket
port 2	Male thread, conical (NPT)
execution	1-part
design	Knee
angle	90 °
press contour	U

Technical properties

maximum working pressure at 20 ° C	10 bar
------------------------------------	--------

Product information

VPE1	10,00 SA1
VPE2	120,00 KT1
weight	0,134 KGM
text	KELOX-ULTRAX elbow adapter 90° male
INTRNR	74122000
main material group	KELOX
material group	KELOX-ULTRAX metal fittings
code	KMU460

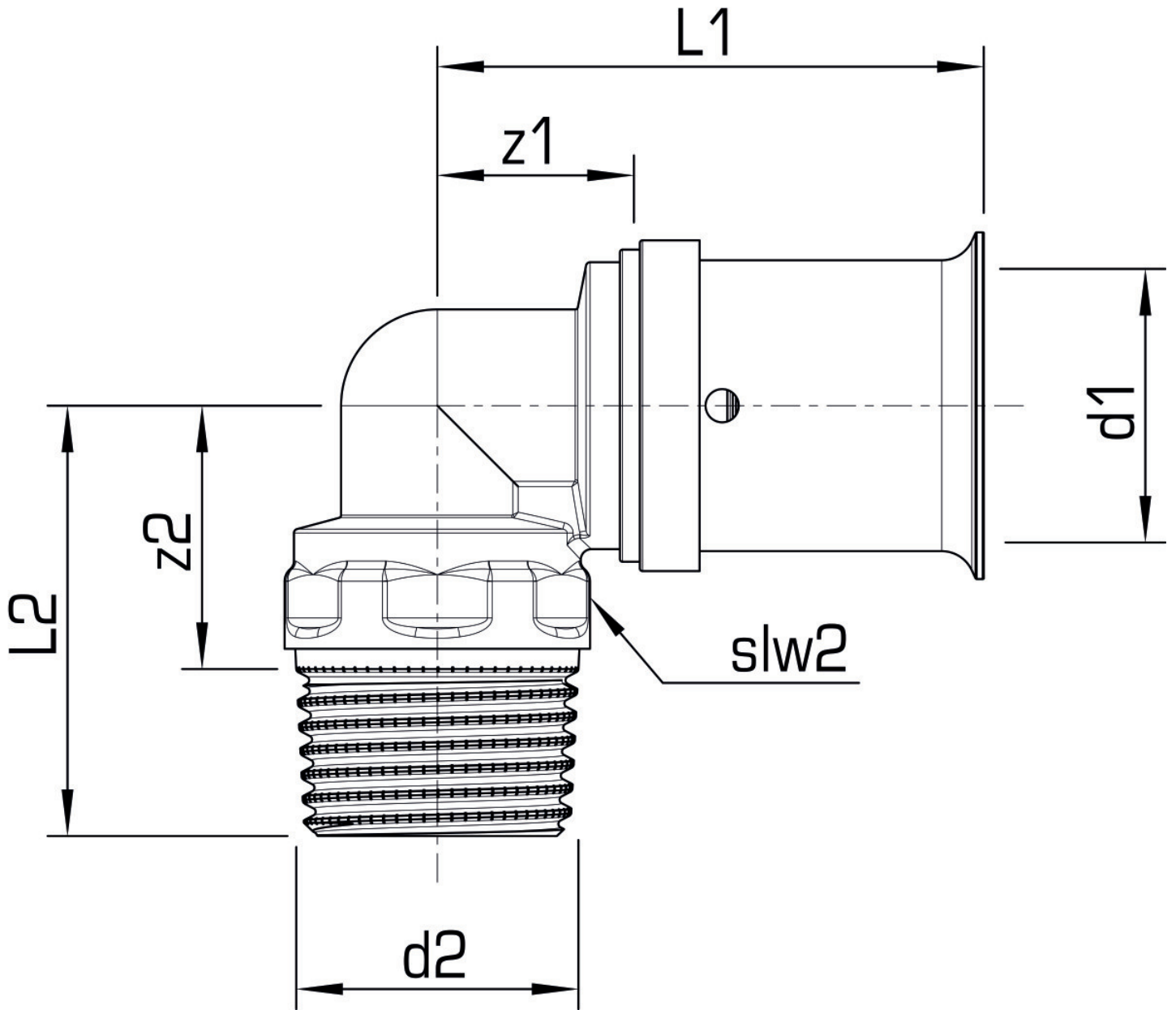

Art. No	label	d2 Inches	d1 mm	L1 mm	L2 mm	z1 mm	z2 mm	slw2 mm
71212D04	20x3/4"	3/4" (20)	20	41	42	18	27	28