

KELOX

KMU485 KELOX-ULTRAX connection set 20x1/2" 8-10cm

71262D02

Areas of application



With KMU480 wall bracket fitting elbow 90°, sound-insulated, stopper, metal mount, plugs and fastening elements

DO NOT screw in any threaded pipes and cast iron fittings!

Approvals:



KE KELIT GmbH

A 4020 Linz, Ignaz-Mayer-Straße 17, Austria, Europe

PHONE +43 (0) 50 779 E-MAIL office@kekelit.com

www.kekelit.com

Specifications

Product information

VPE1	1,00 KT1
VPE2	15,00 KT2
weight	0,913 KGM
text	KELOX-ULTRAX connection set
INTRNR	74122000
main material group	KELOX
material group	KELOX-ULTRAX metal fittings
code	KMU485

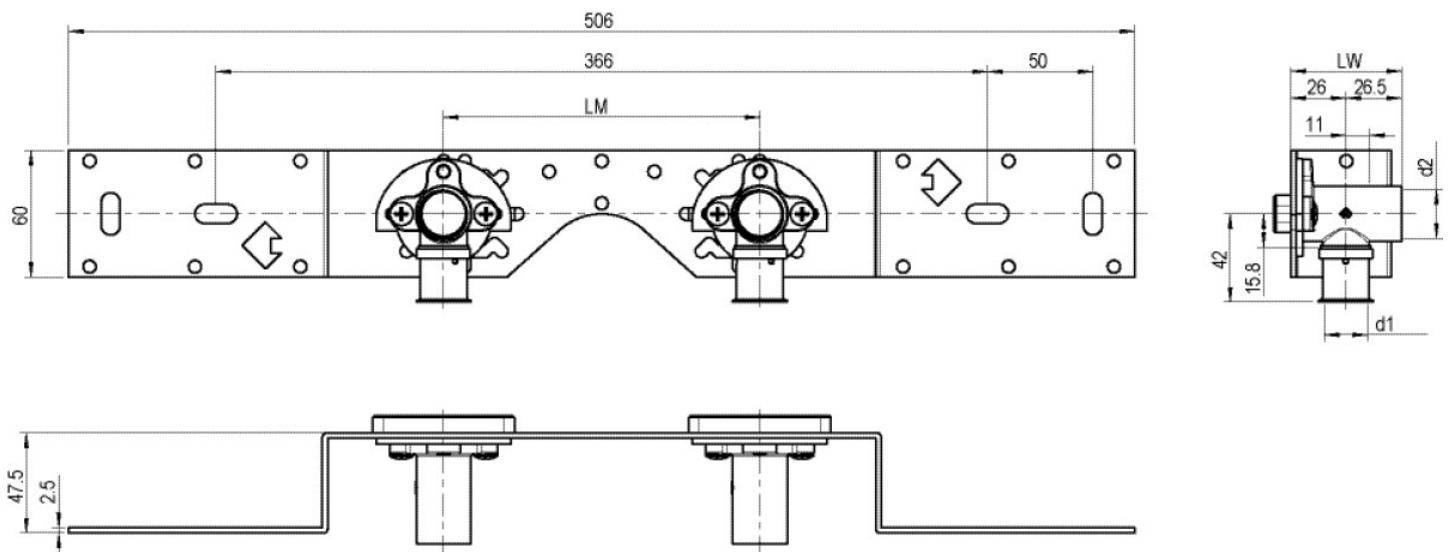

Art. No

label

71262D02

20x1/2" 8-10cm



KE KELIT GmbH

A 4020 Linz, Ignaz-Mayer-Straße 17, Austria, Europe

PHONE +43 (0) 50 779 E-MAIL office@kekelit.com

www.kekelit.com

2/2

04.12.2024