

KELOX

KMP447 KELOX-PROTEC adapter tee female 25x3/4"

73240E04

Areas of application

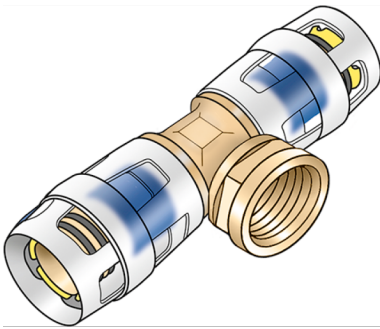

Plug-in tee with female thread, made of dezincification-resistant brass (DZR); support sleeves, O-rings, withdrawal barriers and protector ring as insertion locking device
DO NOT screw in any threaded pipes and cast iron fittings!

Approvals:



KE KELIT GmbH

A 4020 Linz, Ignaz-Mayer-Straße 17, Austria, Europe

PHONE +43 (0) 50 779 E-MAIL office@kekelit.com

www.kekelit.com

Specifications

Article information

port 1	Plug-in
port 2	Female thread metric
port 3	Plug-in
execution	Tee piece
angle	90 °

Technical properties

maximum working pressure at 20 ° C	10 bar
------------------------------------	--------

Product information

VPE1	4,00 SA1
VPE2	44,00 KT1
weight	0,198 KGM
text	KELOX-PROTEC adapter tee female
INTRNR	74122000
main material group	KELOX
material group	KELOX-PROtec pushfittings
code	KMP447

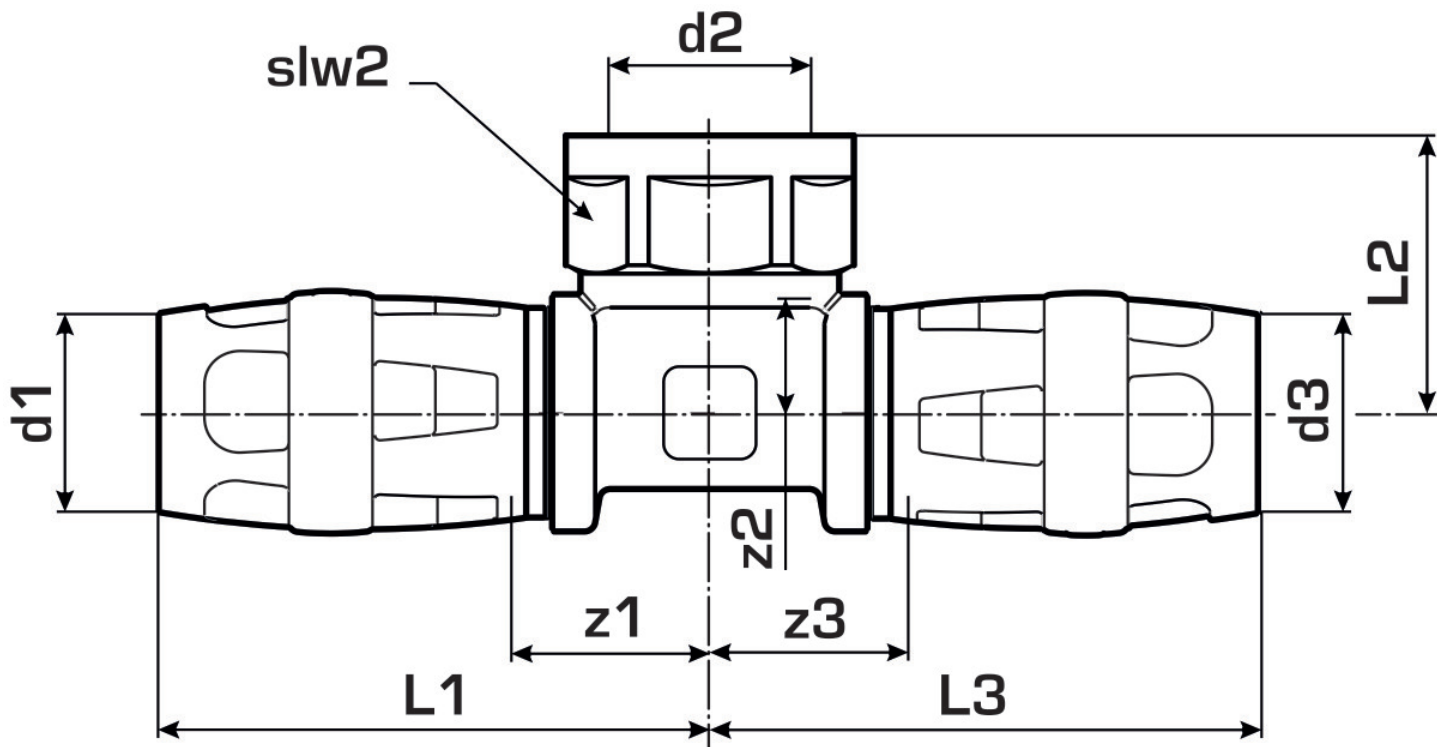

Art. No	label	d2	d1 mm	d3 mm	L1 mm	L2 mm	L3 mm	z1 mm	z2 mm	z3 mm	slw1 mm
73240E0	25x3/4"	3/4" (20)	25	25	61	34,5	61	21,5	15	21,5	30