

KELOX

KMP457 KELOX-PROTEC adapter with female thread 20x3/4"

73206D04

Areas of application

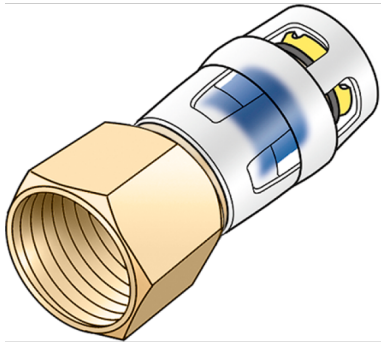

Plug-in adapter with female thread, made of dezincification-resistant brass (DZR); support sleeves, O-rings, withdrawal barriers and protector ring as insertion locking device
DO NOT screw in any threaded pipes and cast iron fittings!

Approvals:



Specifications

Article information

port 1	Plug-in
port 2	Female thread cylindrical BSPT-Rp (ISO 7-1)
design	Straight

Technical properties

maximum working pressure at 20 ° C	10 bar
------------------------------------	--------

Product information

VPE1	10,00 SA1
VPE2	150,00 KT1
weight	0,118 KGM
text	?KELOX-PROTEC adapter with female thread
INTRNR	74122000
main material group	KELOX
material group	KELOX-PROtec pushfittings
code	KMP457

slw2

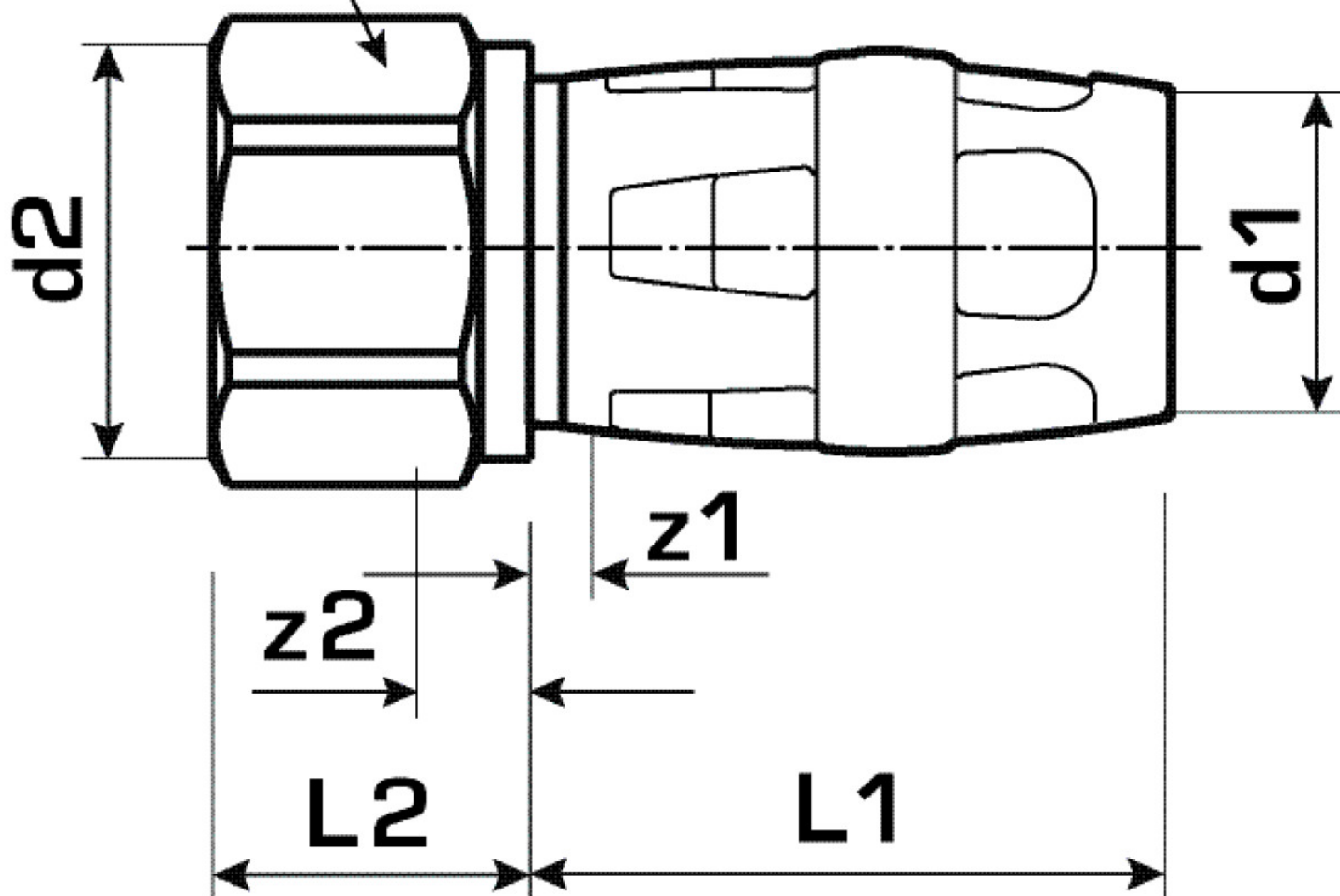

Art. No	label	d1 mm	L1 mm	L2 mm	z1 mm	z2 mm	slw1 mm
73206D04	20x3/4"	20	36	19,5	3	6,5	32