

STEELOX

SMX460 ?STEELOX 90° adapter elbow with male thread 20x3/4"

57212D04

Areas of application

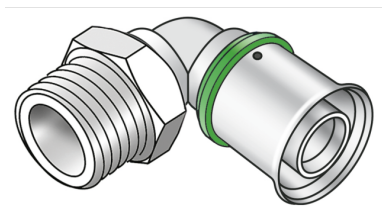

?Press-fit adapter elbow with male thread for sealing, made of non-porous metallised dezincification-resistant (DZR) brass, incl. support sleeves with O-rings and stainless steel pressing sleeves, "leak before pressed"

Approvals:



KE KELIT GmbH

A 4020 Linz, Ignaz-Mayer-Straße 17, Austria, Europe

PHONE +43 (0) 50 779 E-MAIL office@kekelit.com

www.kekelit.com

Specifications

Article information

port 1	Pressing socket
port 2	Male thread, conical (NPT)
execution	1-part
design	Knee
angle	90 °
press contour	SX

Technical properties

maximum working pressure at 20 ° C	10 bar
------------------------------------	--------

Product information

VPE1	10,00 SA1
VPE2	120,00 KT1
weight	0,140 KGM
text	?STEELOX 90° adapter elbow with male thread
INTRNR	74122000
code	SMX460

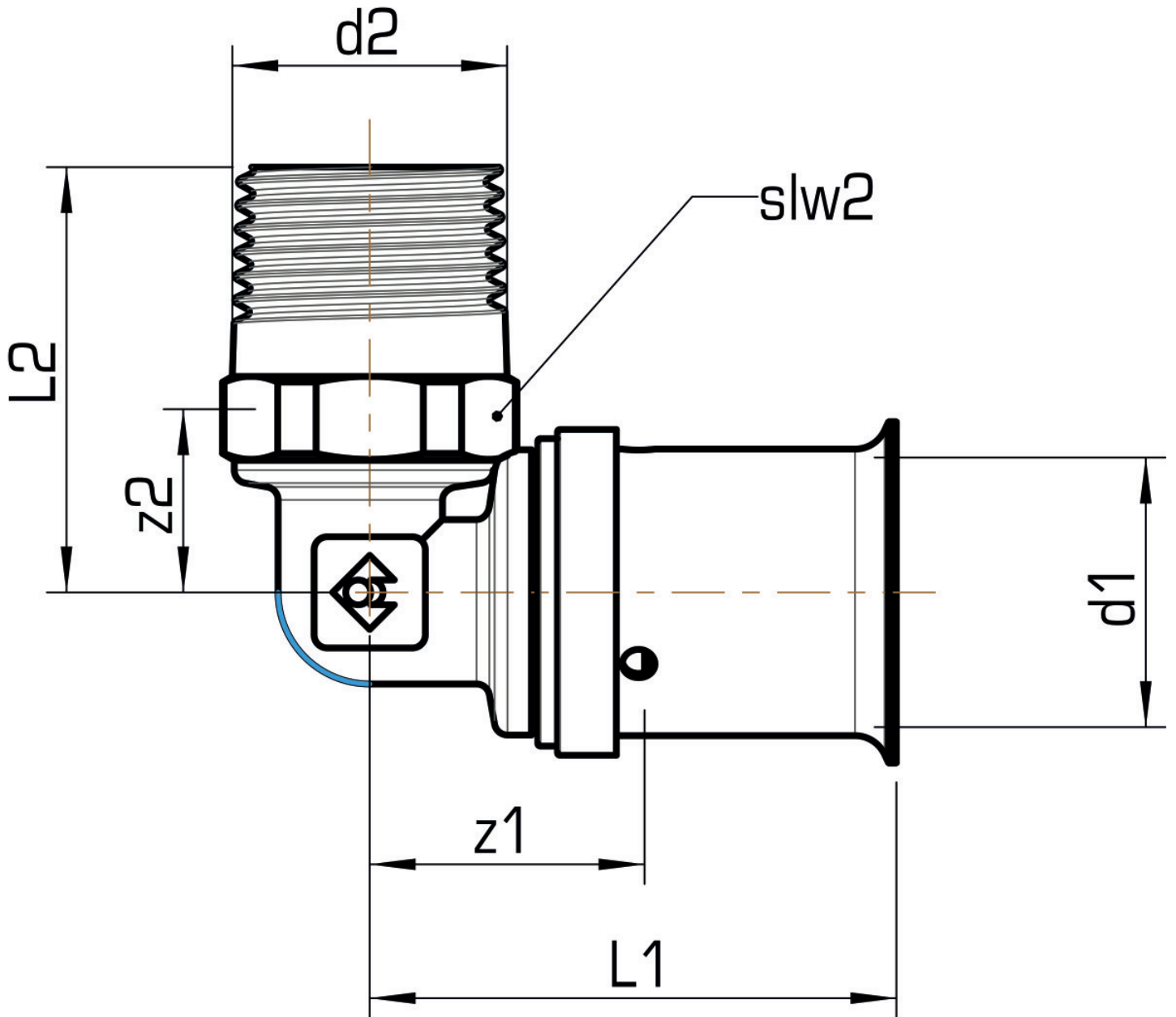

Art. No	label	d2 Inches	d1 mm	L1 mm	L2 mm	z1 mm	z2 mm	slw1 mm	slw2 mm
57212D04	20x3/4"	3/4" (20)	20	41	42	16	42	30	21