

STEEL FIX C-STAHL

CP454 C-steel press-connector straight female
18x3/4"

54705C04

Areas of application

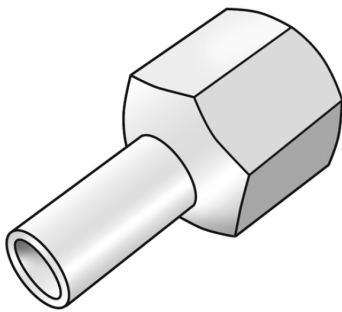

Press-adaptor with female thread made of C-steel with pipe dimensions and coated with a zinc layer

Specifications

Article information

port 1	Zapfen/Rohrende
port 2	Innengewinde zylindrisch BSPT-Rp (ISO 7-1 / EN 10226-1)
execution	1-teilig
design	gerade
press contour	M

Technical properties

maximum working pressure at 20 ° C	16 bar
------------------------------------	--------

Product information

VPE1	10 SA1
VPE2	100 KT1
weight	0,079 KGM
text	C-steel press-connector straight female
INTRNR	73079980
main material group	STEELFIX
material group	C-STAHL pressfittings
code	CP454

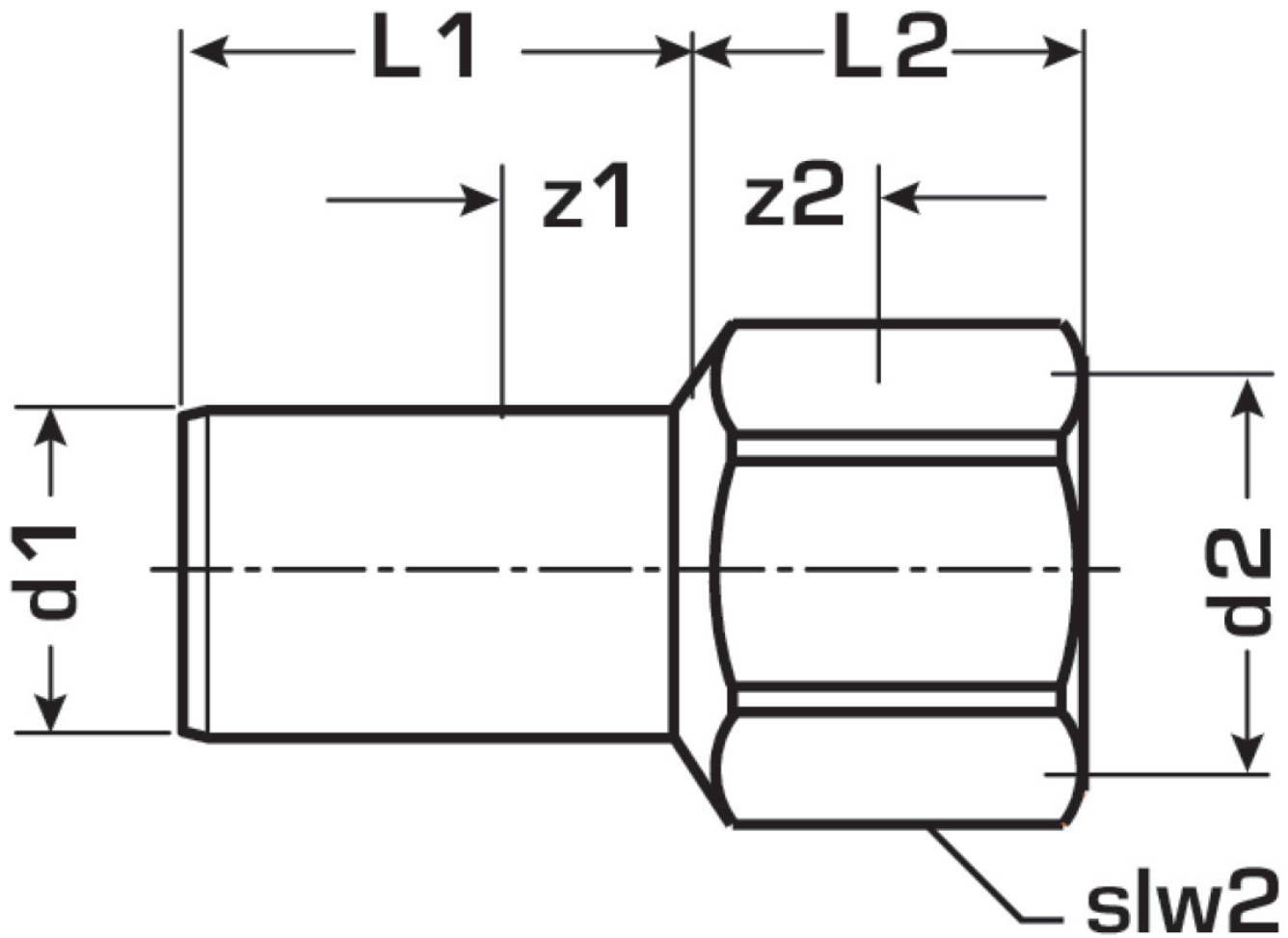

Art. No	label	d2	d1 mm	L1 mm	L2 mm	z1 mm	slw2 mm
54705C04	18x3/4"	3/4 Zoll (20)	18	30	23	10	30