

STEEL FIX C-STAHl

CP457 C-Steel press-adaptor female 18x3/4"

54706C04

Areas of application

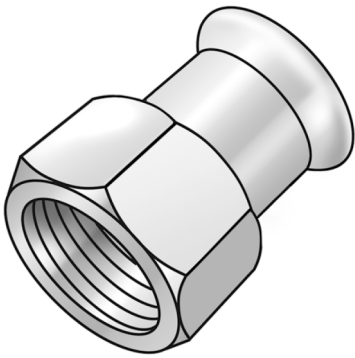

Press-fit adaptor with female thread made of carbon steel coated with a zinc layer, incl. EPDM sealing components, d15-54 "leak before pressed"

Press contour: M

Specifications

Article information

port 1	Pressmuffe
port 2	Innengewinde zylindrisch BSPT-Rp (ISO 7-1 / EN 10226-1)
execution	1-teilig
design	gerade
press contour	M

Technical properties

maximum working pressure at 20 ° C	16 bar
------------------------------------	--------

Product information

VPE1	10 SA1
VPE2	100 KT1
VPE3	2500 DDP
weight	0,07 KGM
text	C-Steel press-adaptor female
INTRNR	73079980
main material group	STEELFIX
material group	C-STAHL pressfittings
code	CP457

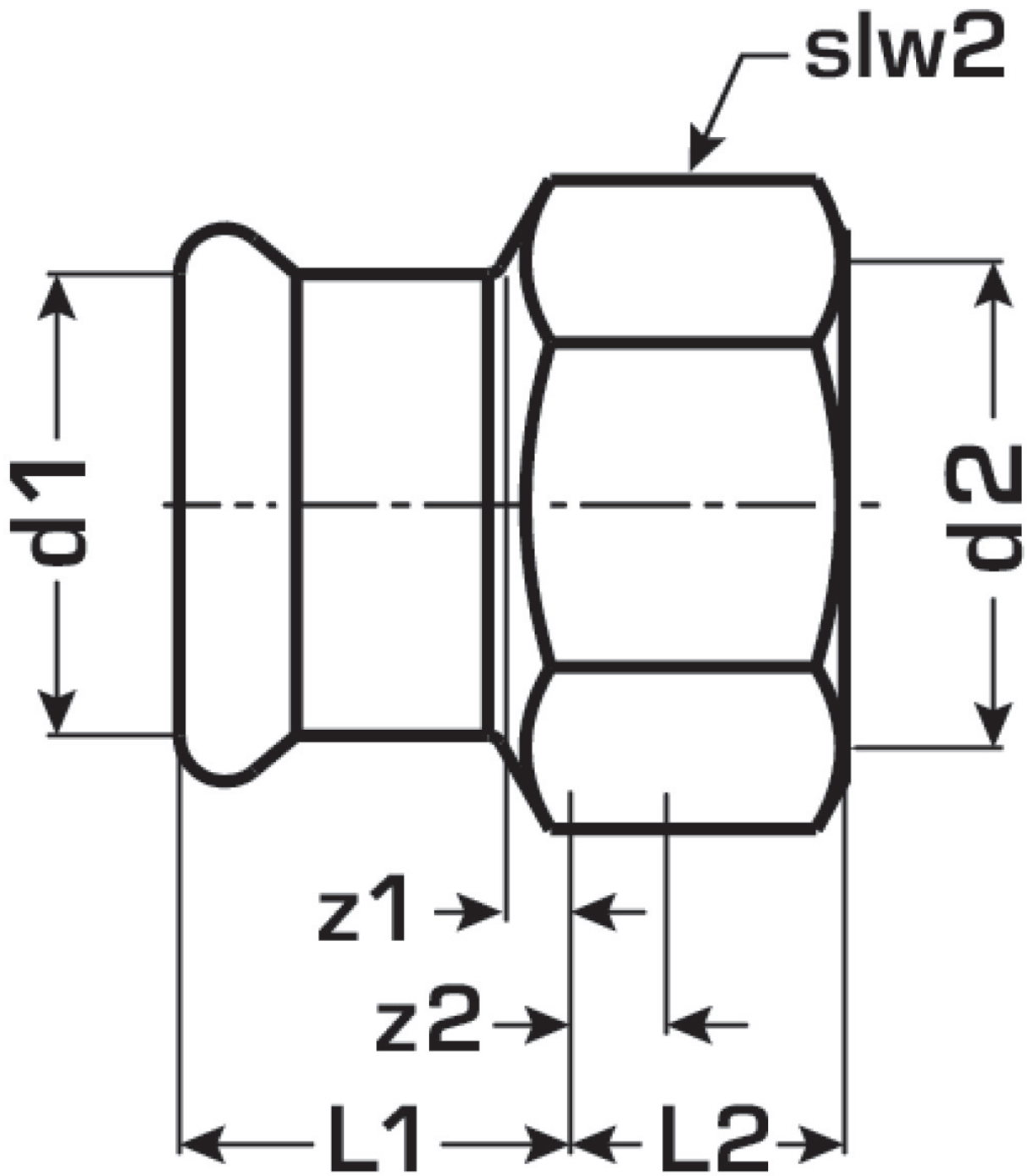

Art. No	label	d2	d1 mm	L1 mm	L2 mm	z1 mm	z2 mm	slw2 mm
54706C04	18x3/4"	3/4 Zoll (20)	18	23	20	3	4	35