

# STEEL FIX C-STAHL

CP467 C-Steel press-elbow adaptor 90° female  
22x1/2"

54716D02

## Areas of application



Press-fit elbow adaptor 90° with female thread made of carbon steel coated with a zinc layer, incl. EPDM sealing components, d15-54 "leak before pressed"

Press contour: M

# Specifications

## Article information

port 1	Pressmuffe
port 2	Innengewinde zylindrisch BSPT-Rp (ISO 7-1 / EN 10226-1)
execution	1-teilig
design	Bogen
angle	90 °
press contour	M

## Technical properties

maximum working pressure at 20 ° C	16 bar
------------------------------------	--------

## Product information

VPE1	10 SA1
VPE2	50 KT1
VPE3	1250 DDP
weight	0,246 KGM
text	C-Steel press-elbow adaptor 90° female
INTRNR	73079980
main material group	STEELFIX
material group	C-STAHL pressfittings
code	CP467

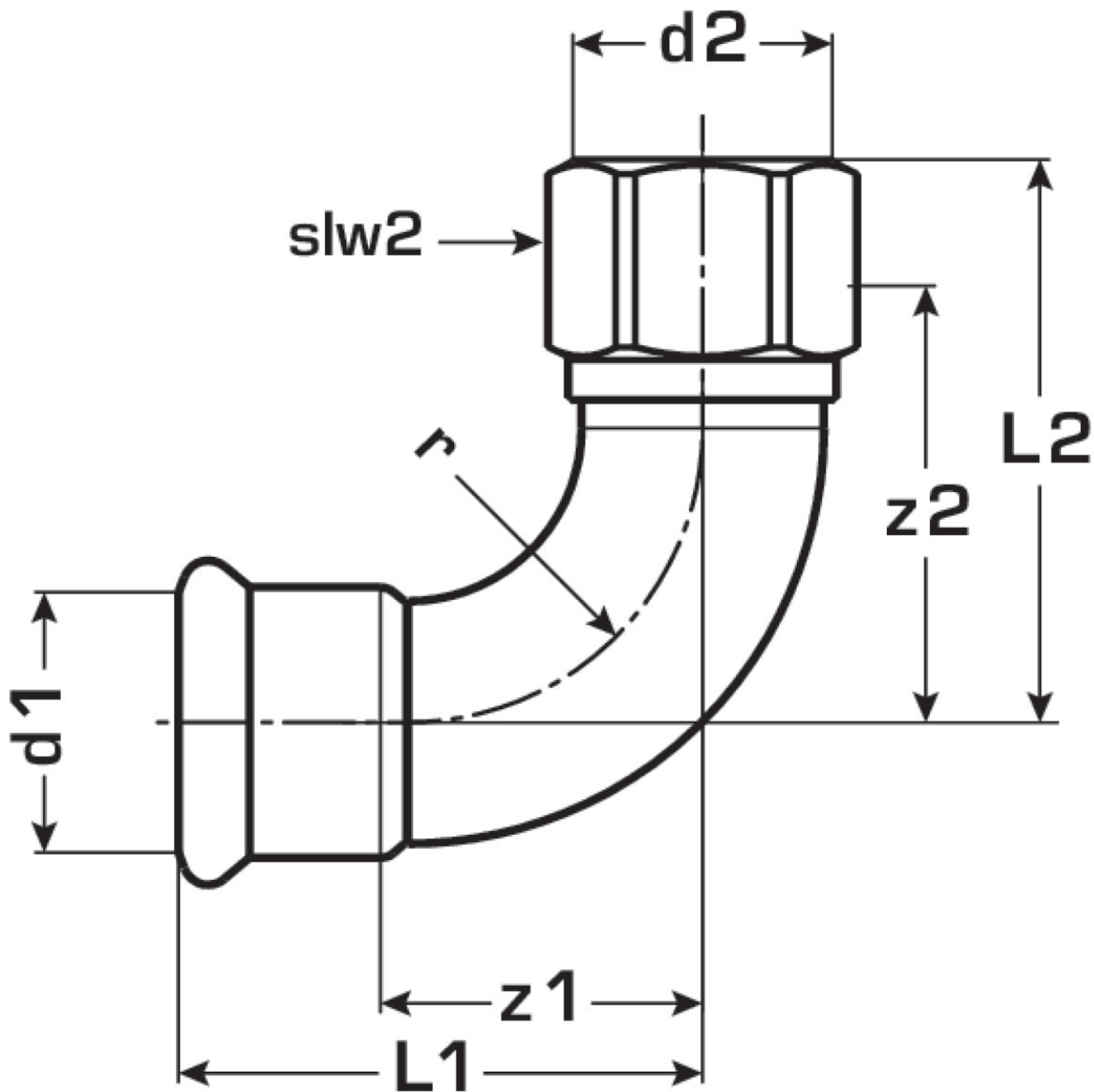

Art. No	label	d2	d1 mm	L1 mm	L2 mm	z1 mm	z2 mm	slw2 mm
54716D02	22x1/2"	1/2 Zoll (15)	22	51	59	30	44	27