

STEEL FIX EDELSTAHL

NP447 Stainless steel press-tee with branch female 28x3/4"

53740E04

Areas of application

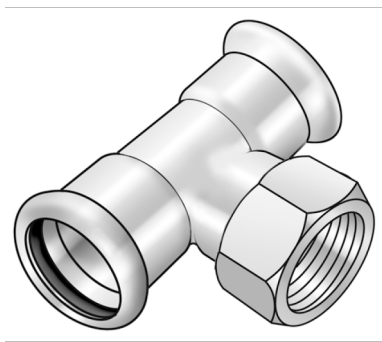

Press-fit tee with threaded branch female made of stainless steel 1.4404, incl. EPDM sealing components, d15-54 "leak before pressed"

Press contour: M

Approvals:



Specifications

Article information

port 1	Pressmuffe
port 2	Innengewinde konisch (NPT)
port 3	Pressmuffe
execution	T-Stück
press contour	M

Technical properties

maximum working pressure at 20 ° C	16 bar
------------------------------------	--------

Product information

VPE1	5 SA1
VPE2	30 KT1
VPE3	750 DDP
weight	0,17 KGM
text	Stainless steel press-tee with branch female
INTRNR	73072980
main material group	STEELFIX
material group	EDELSTAHL pressfittings
code	NP447

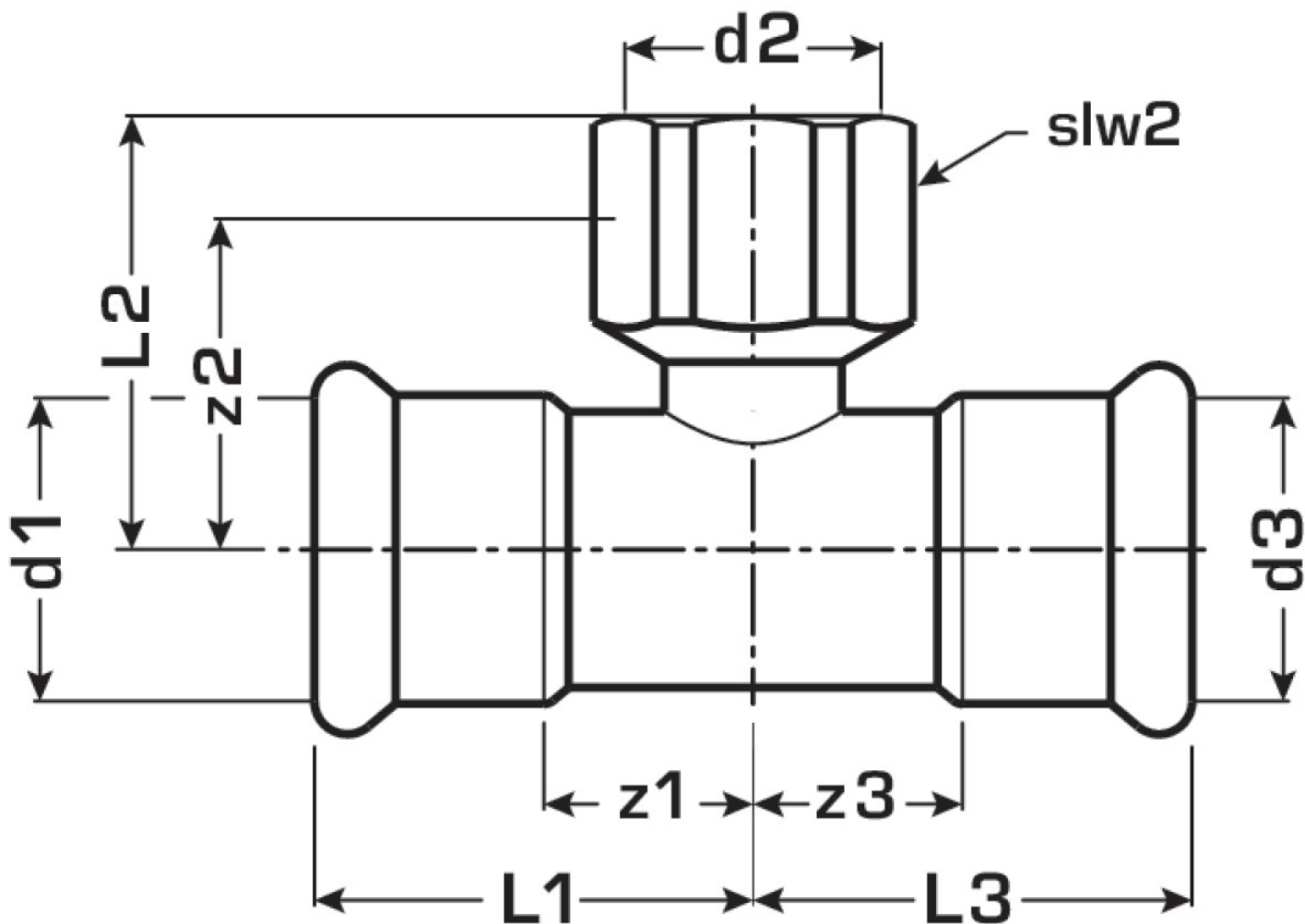

Art. No	label	d2	d1 mm	d3 mm	L1 mm	L2 mm	L3 mm	z1 mm	z2 mm	z3 mm	slw1 mm
53740E0	28x3/4"	3/4 Zoll (20)	28	28	45	42	45	22	31	22	30