

STEEL FIX EDELSTAHL

NP450 Stainless steel press-adaptor male
22x3/4"

53702D04

Areas of application



Press-fit adaptor with male thread conforming to EN 10226-1 made of stainless steel 1.4404, incl. EPDM sealing components, d15-54 "leak before pressed"

Press contour: M

Approvals:



Specifications

Article information

port 1	Pressmuffe
port 2	Außengewinde konisch (NPT)
execution	1-teilig
design	gerade
press contour	M

Product information

VPE1	10 SA1
VPE2	80 KT1
VPE3	2000 DDP
weight	0,083 KGM
text	Stainless steel press-adaptor male
INTRNR	73072980
main material group	STEELFIX
material group	EDELSTAHL pressfittings
code	NP450

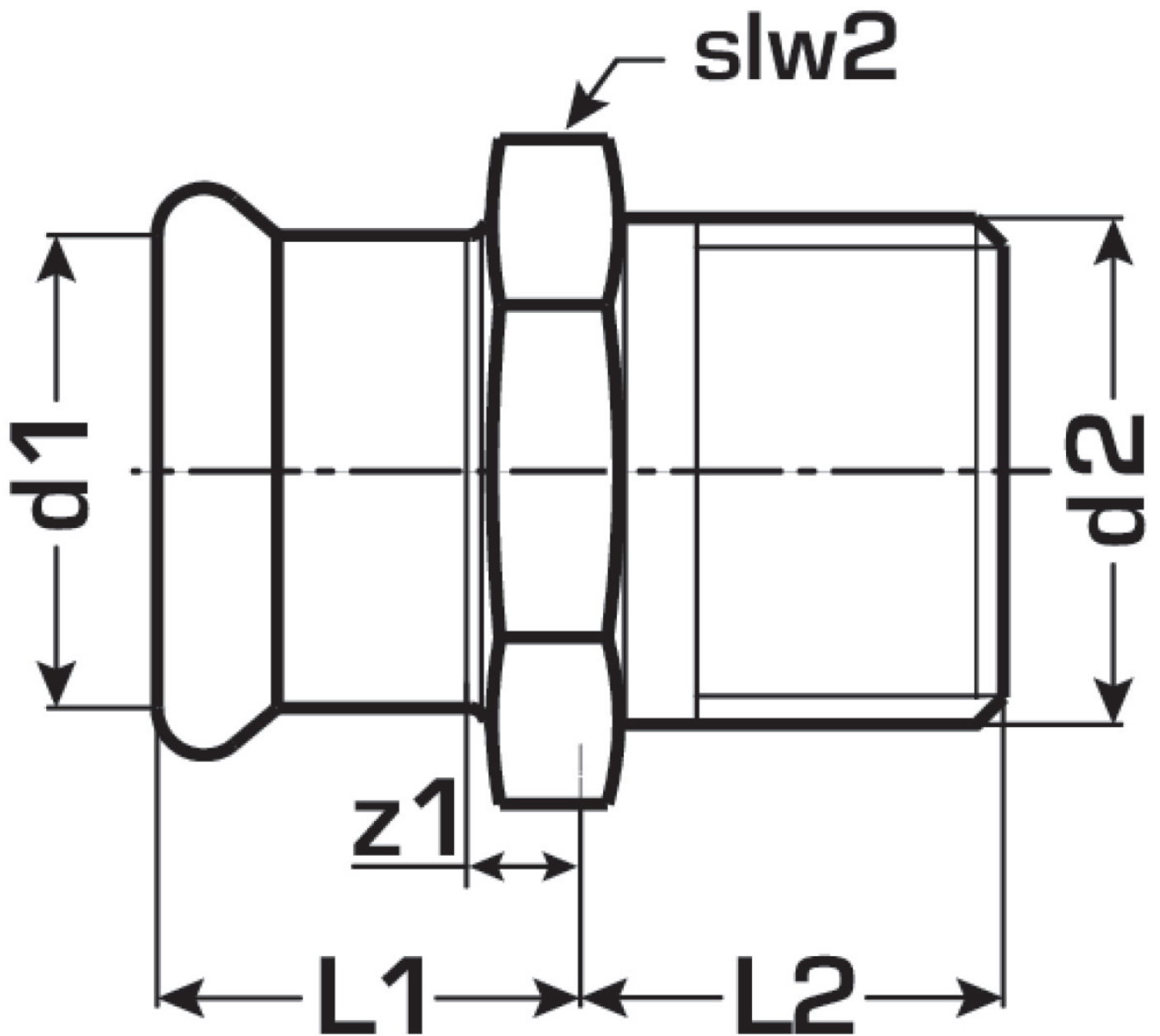

Art. No	label	d2	d1 mm	L1 mm	L2 mm	z1 mm	slw2 mm
53702D04	22x3/4"	3/4 Zoll (20)	22	27	16	6	37