

# KETRIX

## TRI13 KETRIX adapter with female thread 20x3/4"

55212D04

### Areas of application

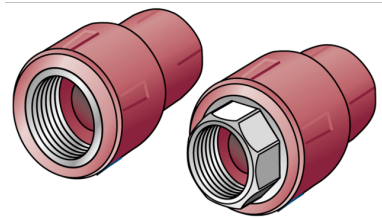

KETRIX polyfusion weld fitting for connecting POB pipes with fittings made of the same material without narrowing the cross-section, with injected male thread made of dezincification-resistant brass and non-porous metal-plating, thread conforms to ÖNORM EN 10226

System parts marked with an "S" are produced with a wrench attachment connection

Do NOT connect to threaded pipes or to cast iron fittings!

# Specifications

Product information	
VPE1	10,00 SA1
VPE2	80,00 KT1
VPE3	320,00 KT2
VPE4	7680,00 PAL
weight	0,104 KGM
text	KETRIX adapter with female thread
INTRNR	39174000
main material group	KETRIX
material group	KETRIX metal fittings
code	TRI13

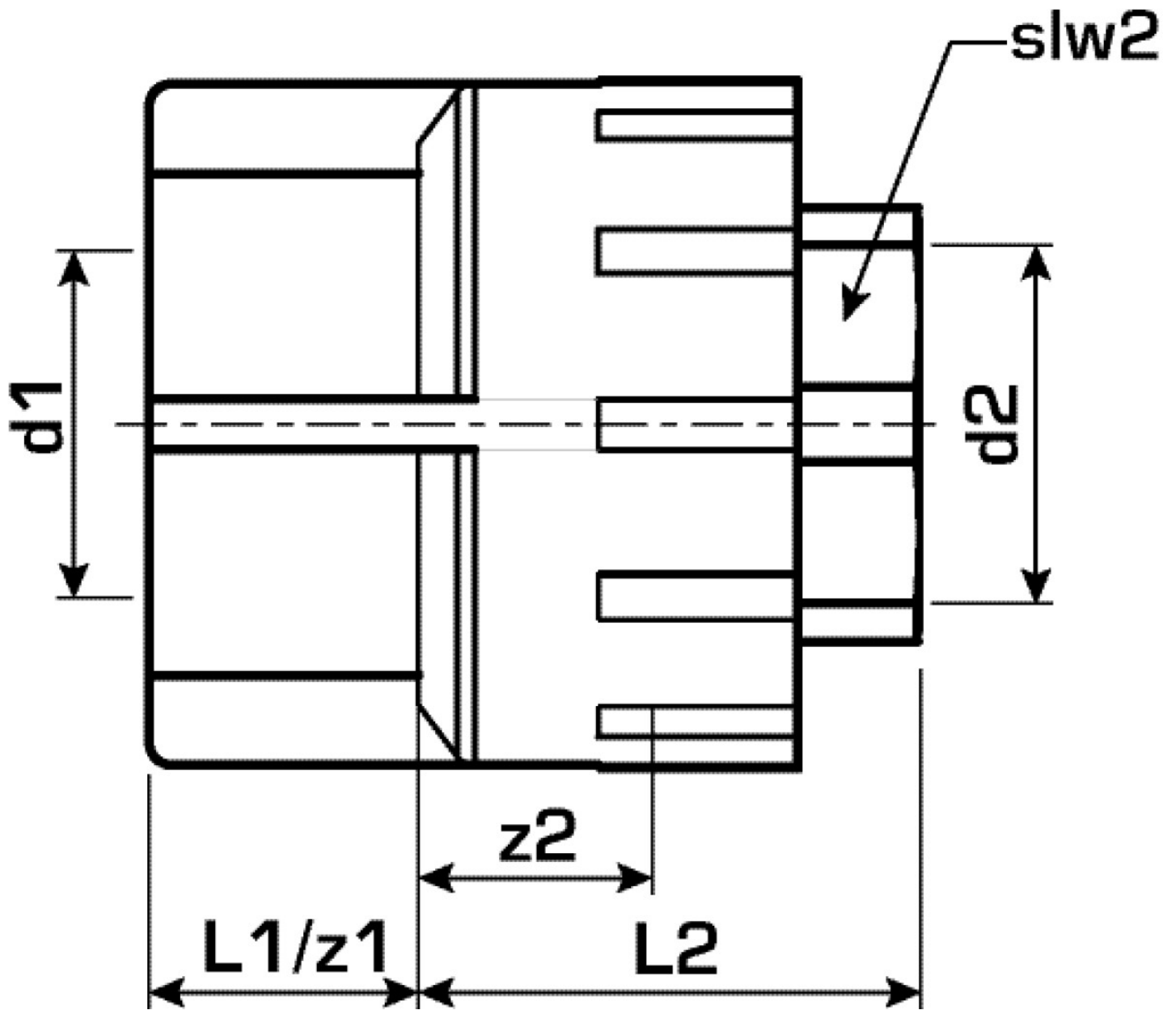

Art. No	label
55212D04	20x3/4"