

CLIMATE FIX

KC590S CLIMATEFIX climate manifold 6/4" 3
L:380mm

7965030

Areas of application

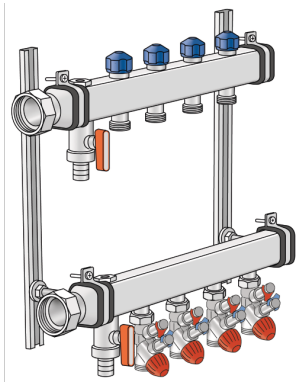

6/4" stainless steel flow and return flow bar with bleeding and emptying at the manifold end, connections with screwed-in 6/4" flat-sealing cap nut.

At the flow compact valve, control valve, regulator valve, shut-off valve and measuring valve 3/4" Euro-cone male, precise regulation with adjusting tools of 0.5 - 9.0 l/min pre-settable, which combines the zone valve and line regulator valve functions, flow and differential pressure measuring can be logged using a monitoring computer

On the return line thermostatic valve for setting the water amount, heating circuit outlets 3/4" euro

cone with male thread, return flow valve bonnets to fit KM596 KELOX thermal motor including soundproofed steel consoles

Area of application: tmax. 80°C/6 bar

ATTENTION: WITHOUT KM220 Euro thread fitting!



KE KELIT GmbH

A 4020 Linz, Ignaz-Mayer-Straße 17, Austria, Europe

PHONE +43 (0) 50 779 **E-MAIL** office@kekelit.com

www.kekelit.com

Specifications

Article information

extendible 0

Product information

VPE1	1,00 KT1
VPE2	32,00 PAL
weight	5,440 KGM
text	CLIMATEFIX climate manifold 6/4"
INTRNR	84818039
main material group	CLIMATEFIX
material group	CLIMATEFIX fittings
code	KC590S

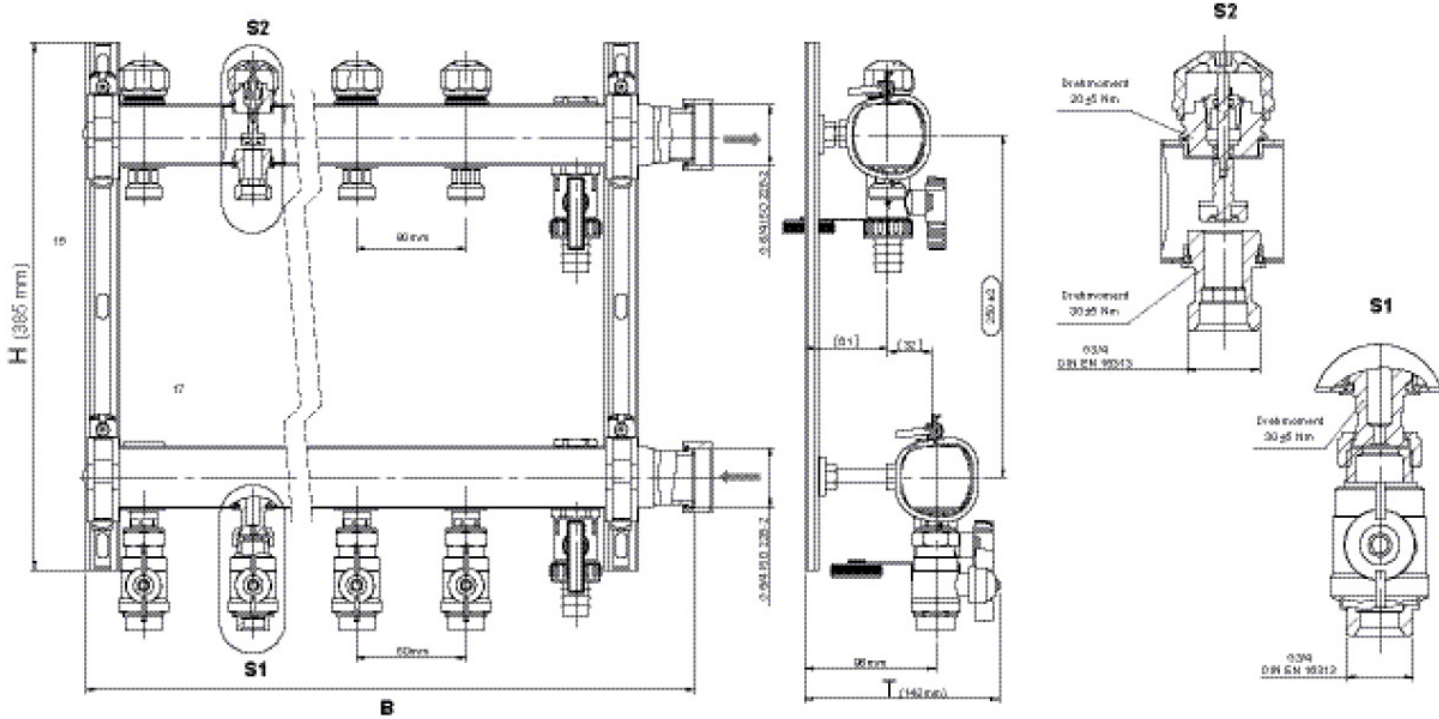

Art. No	label	t mm	t mm	h mm
7965030	3 L:380mm	142	370	385



KE KELIT GmbH
 A 4020 Linz, Ignaz-Mayer-Straße 17, Austria, Europe
PHONE +43 (0) 50 779 **E-MAIL** office@kekelit.com
 www.kekelit.com