

KELOX

KWX450W ?KELOX PPSU-W adapter with male thread 20x1/2"

77702D02

Areas of application

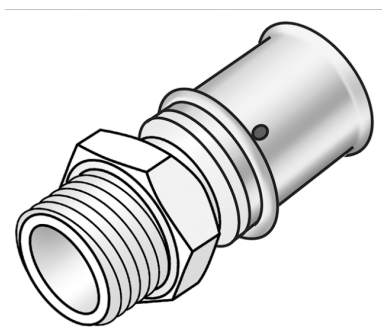

?Press-fit adapter with male thread for sealing with hemp, made of PPSU (white), incl. support sleeves with O-rings and stainless steel press-fit sleeves, "leak before pressed"
DO NOT use liquid sealants or thread sealing tape!

Approvals:



KE KELIT GmbH

A 4020 Linz, Ignaz-Mayer-Straße 17, Austria, Europe

PHONE +43 (0) 50 779 E-MAIL office@kekelit.com

www.kekelit.com

Specifications

Article information

port 1	Pressmuffe
port 2	Außengewinde konisch (NPT)
press contour	U

Technical properties

maximum working pressure at 20 ° C	16 bar
------------------------------------	--------

Product information

VPE1	10,00 SA1
VPE2	200,00 KT1
weight	0,027 KGM
text	?KELOX PPSU-W adapter with male thread
INTRNR	39174000
main material group	KELOX
material group	KELOX-PPSU plastic fittings
code	KWX450W

Art. No	label	d1 mm
77702D02	20x1/2"	20