

KELOX

KMP425X KELOX-PROTEC CLIX elbow 45° 32

730106FF0

Areas of application

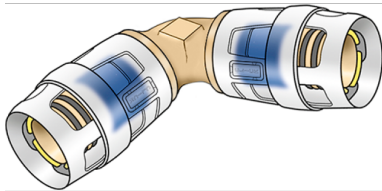

Plug-in elbow 45° for changing direction with a minimal radius, made of dezincification-resistant brass (DZR), including support sleeves with insertion click noise, as well as haptic and optical insertion indicator, O-rings, withdrawal barriers and protector ring as insertion locking device

Approvals:



KE KELIT GmbH

A 4020 Linz, Ignaz-Mayer-Straße 17, Austria, Europe

PHONE +43 (0) 50 779 E-MAIL office@kekelit.com

www.kekelit.com

Specifications

Article information

port 1	Plug-in
port 2	Plug-in
execution	Miscellaneous
design	Knee
angle	45 °

Technical properties

maximum working pressure at 20 ° C	10 bar
------------------------------------	--------

Product information

VPE1	4,00 SA1
VPE2	44,00 KT1
weight	0,229 KGM
text	KELOX-PROTEC CLIX elbow 45°
INTRNR	74122000
main material group	KELOX
material group	KELOX-PROtec pushfittings
code	KMP425X

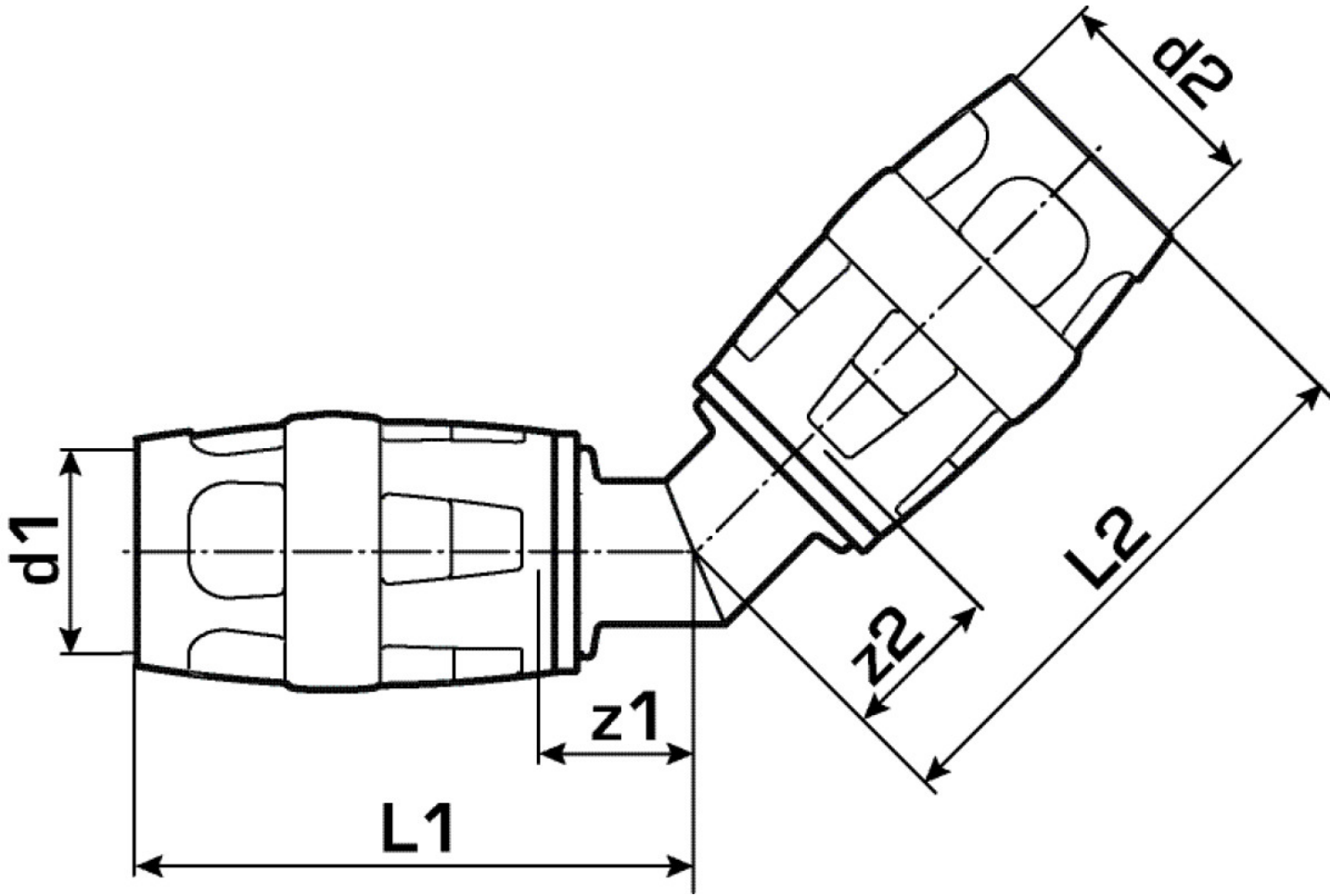

Art. No	label	d1 mm	d2 mm	L1 mm	L2 mm	z1 mm	z2 mm
730106FF0	32	32	32	59	59	20	20