

KELOX

KMP447X KELOX-PROTEC CLIX tee with branch female 32x3/4"

730240F04

Areas of application

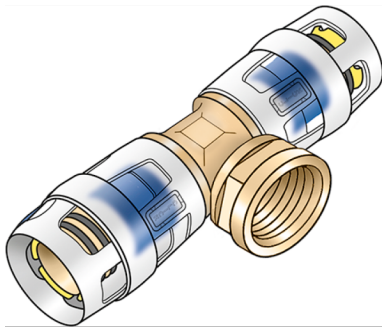

Plug-in tee with female thread, made of dezincification-resistant brass (DZR), including support sleeves with insertion click noise, as well as haptic and optical insertion indicator, O-rings, withdrawal barriers and a protector ring as an insertion locking device
DO NOT screw in any threaded pipes and cast iron fittings!

Approvals:



Specifications

Article information

port 1	Plug-in
port 2	Female thread metric
port 3	Plug-in
execution	Tee piece
angle	90 °

Technical properties

maximum working pressure at 20 ° C	10 bar
------------------------------------	--------

Product information

VPE1	4,00 SA1
VPE2	32,00 KT1
weight	0,295 KGM
text	KELOX-PROTEC CLIX tee with branch female
INTRNR	74122000
main material group	KELOX
material group	KELOX-PROtec pushfittings
code	KMP447X



Art. No	label	d2	d1 mm	d3 mm	L1 mm	L2 mm	L3 mm	z1 mm	z2 mm	z3 mm	slw1 mm
730240F1	32x3/4"	3/4" (20)	32	32	60,5	39	60,5	21,5	22,5	21,5	30