

# KELOX

## KUC130 KELOX-ECO Plus pipe - 9mm 25x2.5

70925205

### Areas of application

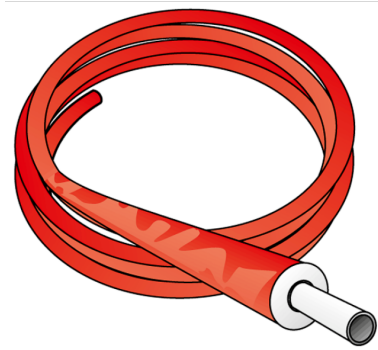

KELOX-ECO solid-wall pipe in accordance with ÖNORM EN ISO 22391 made of PE-RT type 2, with 9mm closed-cell flexible-foam insulation applied at the plant and protective coating made of viscoplastic PE film. Connections can be made using KM compression fittings, KMP, KWP, KMU and KWK fittings

Classification of operating conditions according to ÖNORM EN ISO 22391

Cold water area of application: 20 °C - 10 bar

Warm water application range: 60°C - 6 bar

Colour: red

Supplied in coils

## Approvals:



# Specifications

## Article information

color	weiß
colour isolation	blau
flexible	1
trade length	25 m
isolation	1

## Technical properties

maximum working pressure at 20 ° C	10 bar
thick thermal insulation	9 mm
pipe contents	0,314 l/m
wall rawness	0,007 mm

## Product information

VPE1	25,00 ROL
VPE2	375,00 PAL
L	50
weight	0,310 KGM
text	KELOX-ECO Plus pipe - 9mm
INTRNR	39173900
main material group	KELOX
material group	KELOX isolierte pipes
code	KUC130

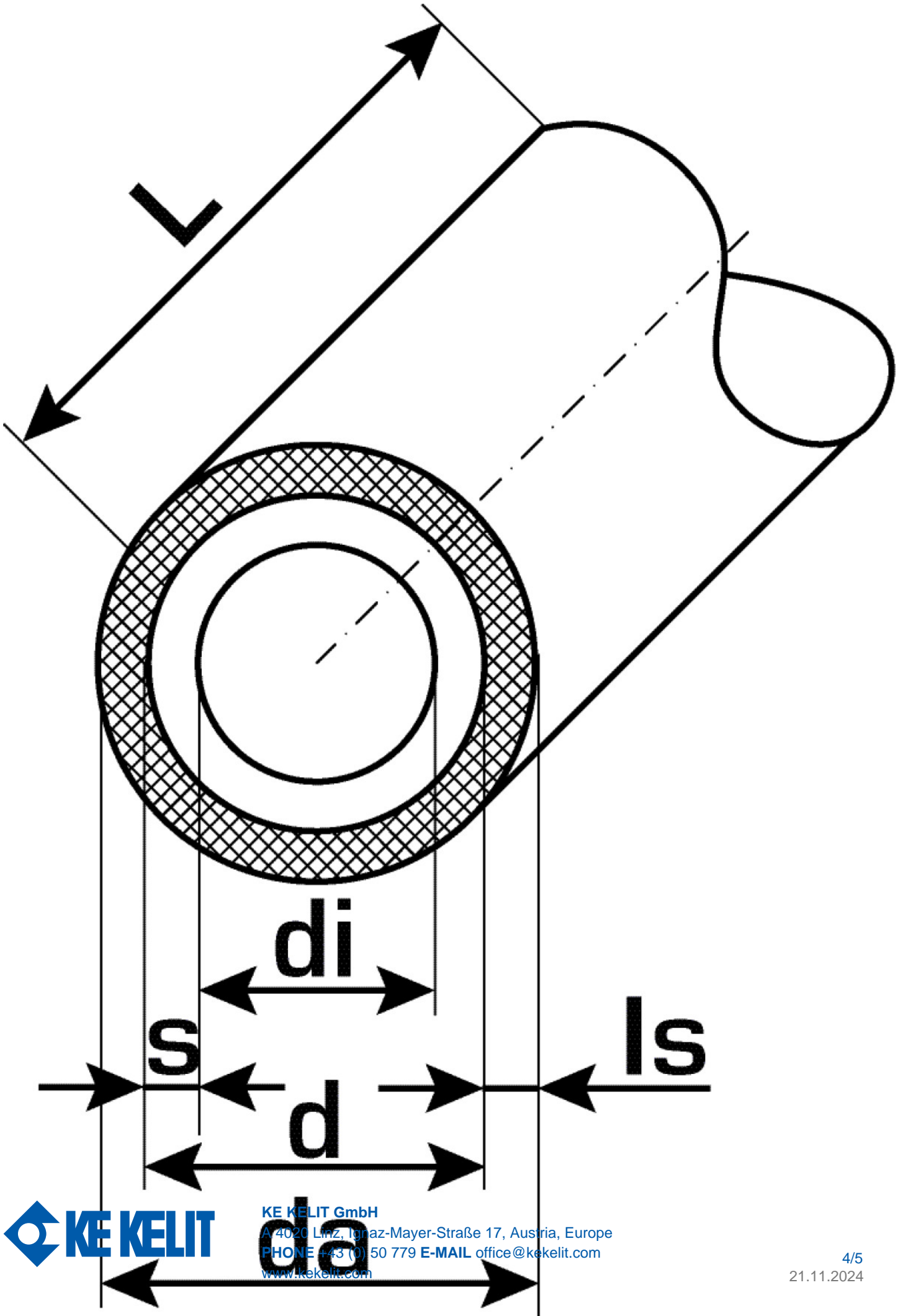

Art. No	label	d1 mm	d Jacket tube mm	pipe contents l/m	s mm
70925205	25x2.5	25	43	0,314	2,5



**KE KELIT GmbH**

A 4020 Linz, Ignaz-Mayer-Straße 17, Austria, Europe

**PHONE** +43 (0) 50 779 **E-MAIL** [office@kekelit.com](mailto:office@kekelit.com)

[www.kekelit.com](http://www.kekelit.com)