

# KELOX

KM142B KELOX plus pipe - 20mm 25x2.5 blue

75225250

## Areas of application



?KELOX multilayer pipe conforming to ÖNORM EN ISO 21003, oxygen- and water vapour diffusion-tight 5-layer PE-RT/Al/PE-RT composite pipe, with factory-applied 20mm closed-cell soft foam insulation and jacket made of viscoplastic PE film

Classification of operating conditions according to ÖNORM EN ISO 21003

Sanitary application - Class 2: 70°C - tmax 80°C/10 bar

Radiator connection - Class 5: 80°C - tmax 90°C/10 bar

Thermal conductivity according to EN ISO 8497:

Average temperature +20°C - 0.038 W/mK

Average temperature +40°C - 0.040 W/mK

Insulation thickness: 20mm

Supplied in coils

## Approvals:



# Specifications

## Article information

color	weiß
colour isolation	blau
flexible	1
trade length	50,00 m
isolation	1

## Technical properties

maximum working pressure at 20 ° C	10 bar
thick thermal insulation	20 mm
pipe weight	0,26 kg/m
pipe contents	0,189 l/m
lambda pipe	0,45 W/(m.K)
wall rawness	0,007 mm
expansion coefficient	0,025 mm/(m.K)

## Product information

<b>VPE1</b>	50,00 ROL
<b>VPE2</b>	200,00 PAL
<b>L</b>	50 m
<b>weight</b>	0,400 KGM
<b>text</b>	KELOX plus pipe - 20mm
<b>INTRNR</b>	39173900
<b>main material group</b>	KELOX
<b>material group</b>	KELOX isolierte pipes
<b>code</b>	KM142B

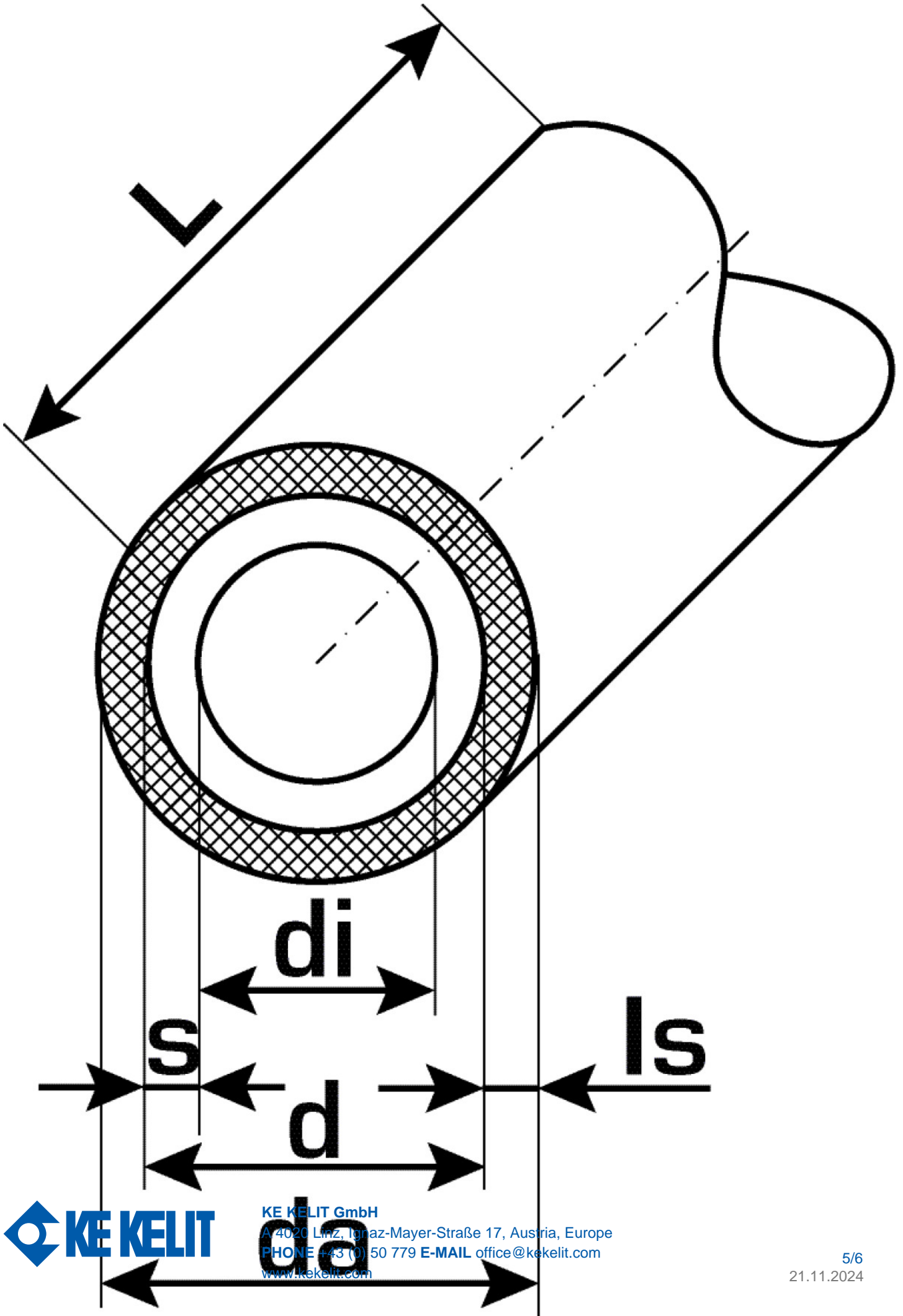

Art. No	label	d1 mm	d Jacket tube mm	pipe contents l/m	s mm
75225250	25x2.5 blue	25	65	0,189	2,5



**KE KELIT GmbH**

A 4020 Linz, Ignaz-Mayer-Straße 17, Austria, Europe

**PHONE** +43 (0) 50 779 **E-MAIL** [office@kekelit.com](mailto:office@kekelit.com)

[www.kekelit.com](http://www.kekelit.com)