

KELOX

KMW483 KELOX-ULTRAX-W wall duct 90° with female thread 16x1/2 48mm

71456B25

Areas of application

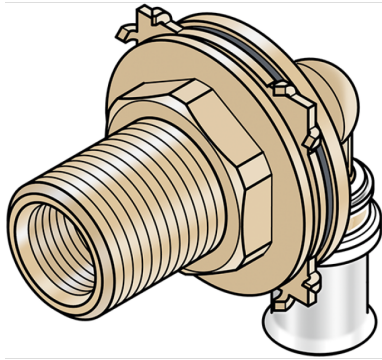

?Zeta value-optimised press-fit wall duct with female thread for drywall construction, made from dezincification-resistant (DZR) brass, including support sleeves with O-rings and stainless steel press-fit sleeves "leak before pressed", audible leakage signal at air-pressure testing
DO NOT screw in threaded pipes and cast iron fittings!

Approvals:



Specifications

Article information

port 1	Pressmuffe
port 2	Außengewinde zylindrisch BSPP (ISO 228-1)
design	Winkel
angle	90 °
press contour	U

Technical properties

maximum working pressure at 20 ° C	16 bar
------------------------------------	--------

Product information

VPE1	2,00 SA1
VPE2	10,00 KT1
VPE3	800,00 PAL
weight	0,335 KGM
text	KELOX-ULTRAX-W wall duct 90° with female thread
INTRNR	74122000
main material group	KELOX
code	KMW483

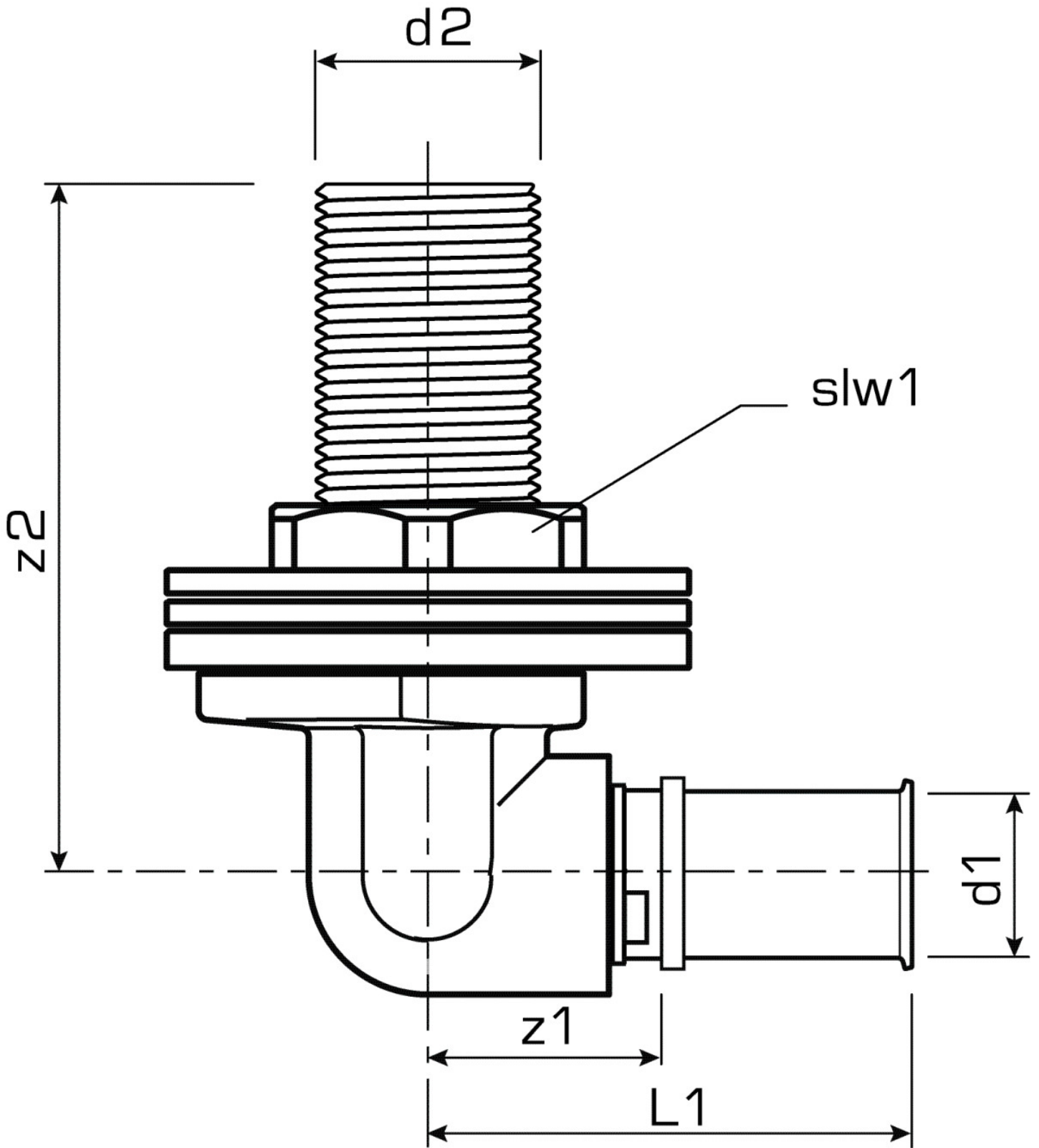

Art. No	label	d2	d1 mm	L2 mm	z1 mm	z2 mm
71456B25	16x1/2 48mm	1/2" (15)	16	48	25	22



KE KELIT GmbH

A 4020 Linz, Ignaz-Mayer-Straße 17, Austria, Europe

PHONE +43 (0) 50 779 **E-MAIL** office@kekelit.com

www.kekelit.com