

KELOX

KM133 KELOX plus pipe - 13mm 25x2.5

75212513

Areas of application

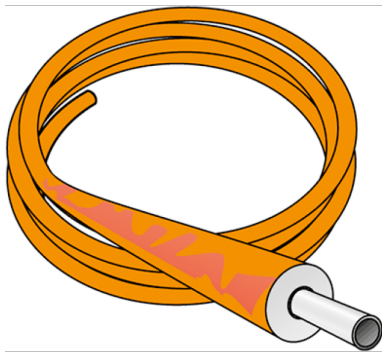

?KELOX multilayer pipe conforming to ÖNORM EN ISO 21003, oxygen- and water vapour diffusion-tight 5-layer PE-RT/Al/PE-RT composite pipe, with factory-applied 13mm closed-cell soft foam insulation and jacket made of viscoplastic PE film

Classification of operating conditions according to ÖNORM EN ISO 21003

Sanitary application - Class 2: 70°C - tmax 80°C/10 bar

Radiator connection - Class 5: 80°C - tmax 90°C/10 bar

Insulation thickness: 13mm

Colour: orange

Supplied in coils

Approvals:



Specifications

Article information

color	White
colour isolation	Orange
flexible	1
isolation	1

Technical properties

maximum working pressure at 20 ° C	10 bar
thick thermal insulation	13 mm
pipe weight	0,36 kg/m
pipe contents	0,314 l/m
lambda pipe	0,45 W/(m.K)
wall rawness	0,007 mm
expansion coefficient	0,025 mm/(m.K)

Product information

VPE1	25,00 ROL
VPE2	325,00 PAL
L	25 m
weight	0,339 KGM
text	KELOX plus pipe - 13mm
INTRNR	39173900
main material group	KELOX
material group	KELOX isolierte pipes
code	KM133

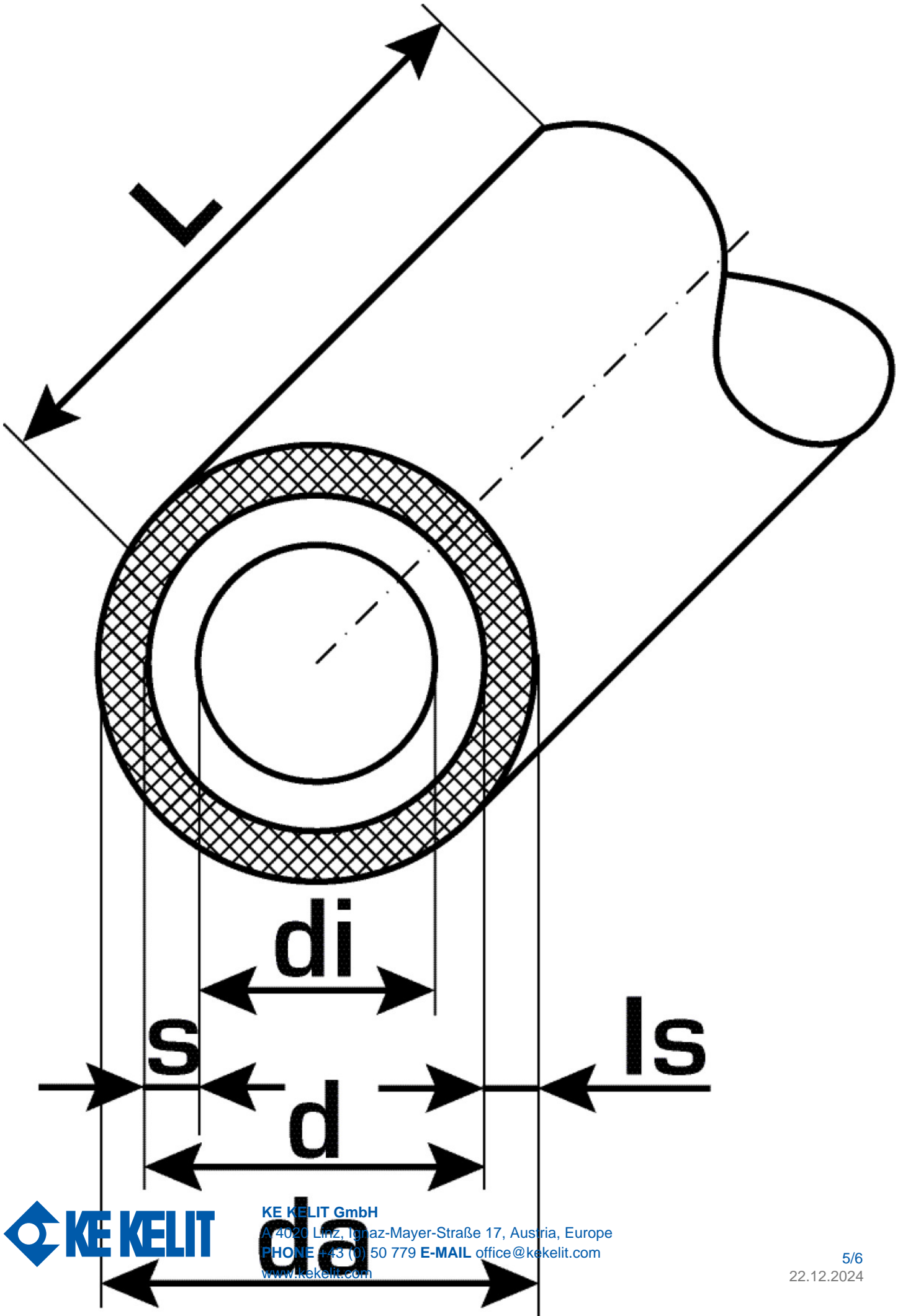

Art. No	label	d1 mm	d Jacket tube mm	pipe contents l/m	s mm
75212513	25x2.5	25	51	0,314	2,5



KE KELIT GmbH

A 4020 Linz, Ignaz-Mayer-Straße 17, Austria, Europe

PHONE +43 (0) 50 779 **E-MAIL** office@kekelit.com

www.kekelit.com