

KELOX

KM441 KELOX double connector tee 20/16/16

9848240

Areas of application

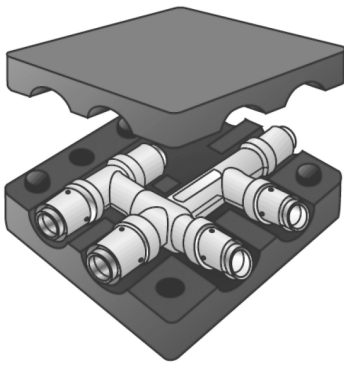

Double press tee piece equal or reduced in noise protection box, made from non-porous metallised brass, including support sleeves with O-rings and stainless steel press-fit sleeves

Size: L: 115mm W: 115mm H: 55mm

Approvals:



Specifications

Article information

port 1	Pressing socket
port 2	Pressing socket
execution	Cross pair
press contour	U

Product information

VPE1	1,00 KT1
weight	0,390 KGM
text	KELOX double connector tee
INTRNR	74122000
main material group	KELOX
material group	KELOX metal fittings
code	KM441

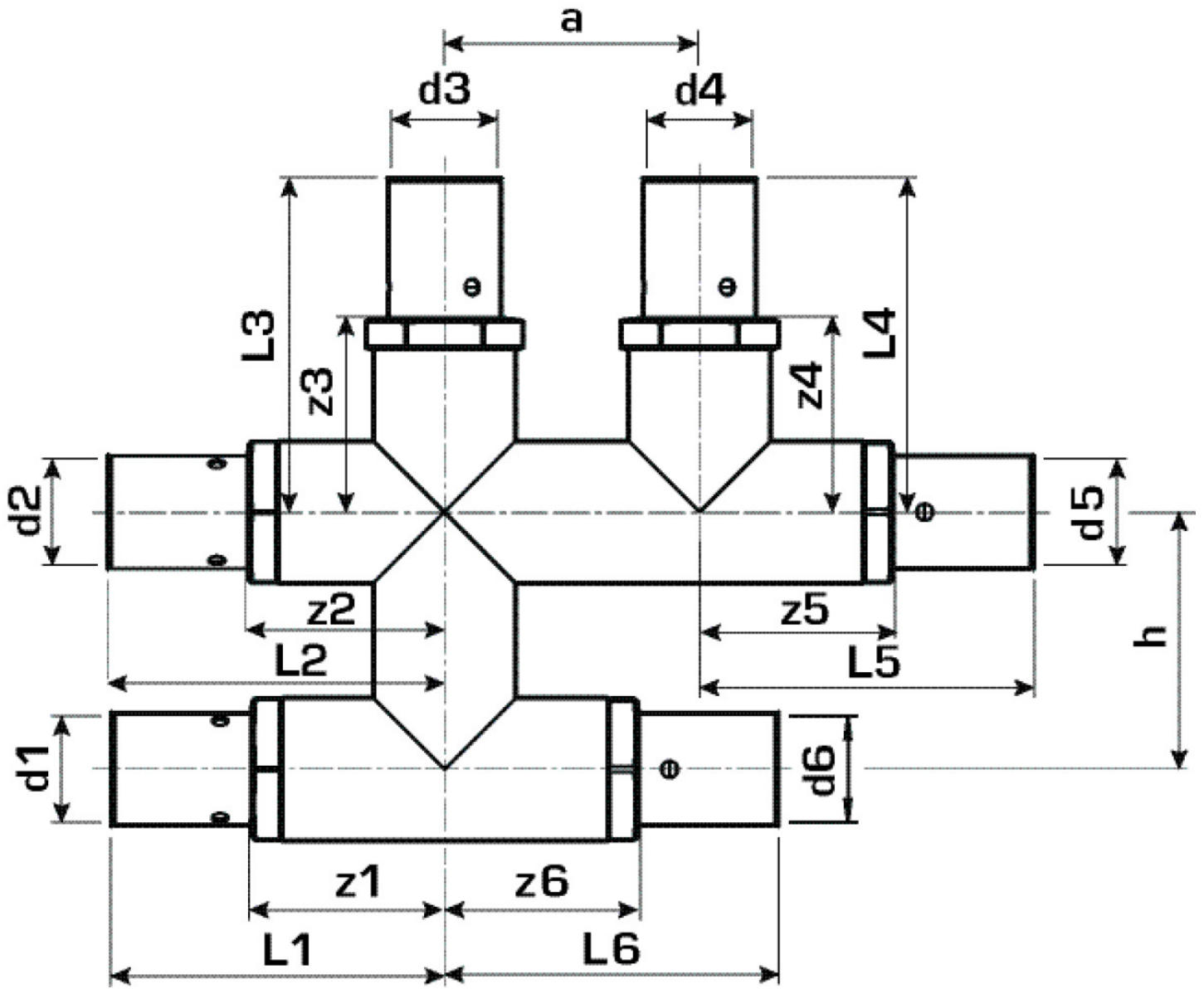

Art. No	label
9848240	20/16/16