

KELOX

KM258 KELOX stopper for pressure testing 16x1/2"

7604160

Areas of application

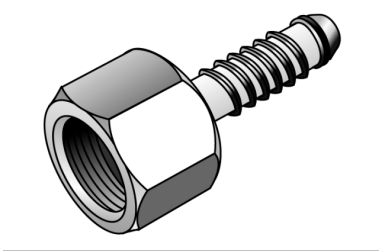

Re-usable plug for forcing off KELOX multilayer pipes

After removing the forcing-off plug, cut off the pipe end!

NOT suitable for continuous use!

Specifications

Technical properties

maximum working pressure at 20 ° C	10
------------------------------------	----

Product information

VPE1	10,00 SA1
VPE2	200,00 KT1
weight	0,105 KGM
text	KELOX stopper for pressure testing
INTRNR	74122000
main material group	KELOX
material group	KELOX accessories
code	KM258

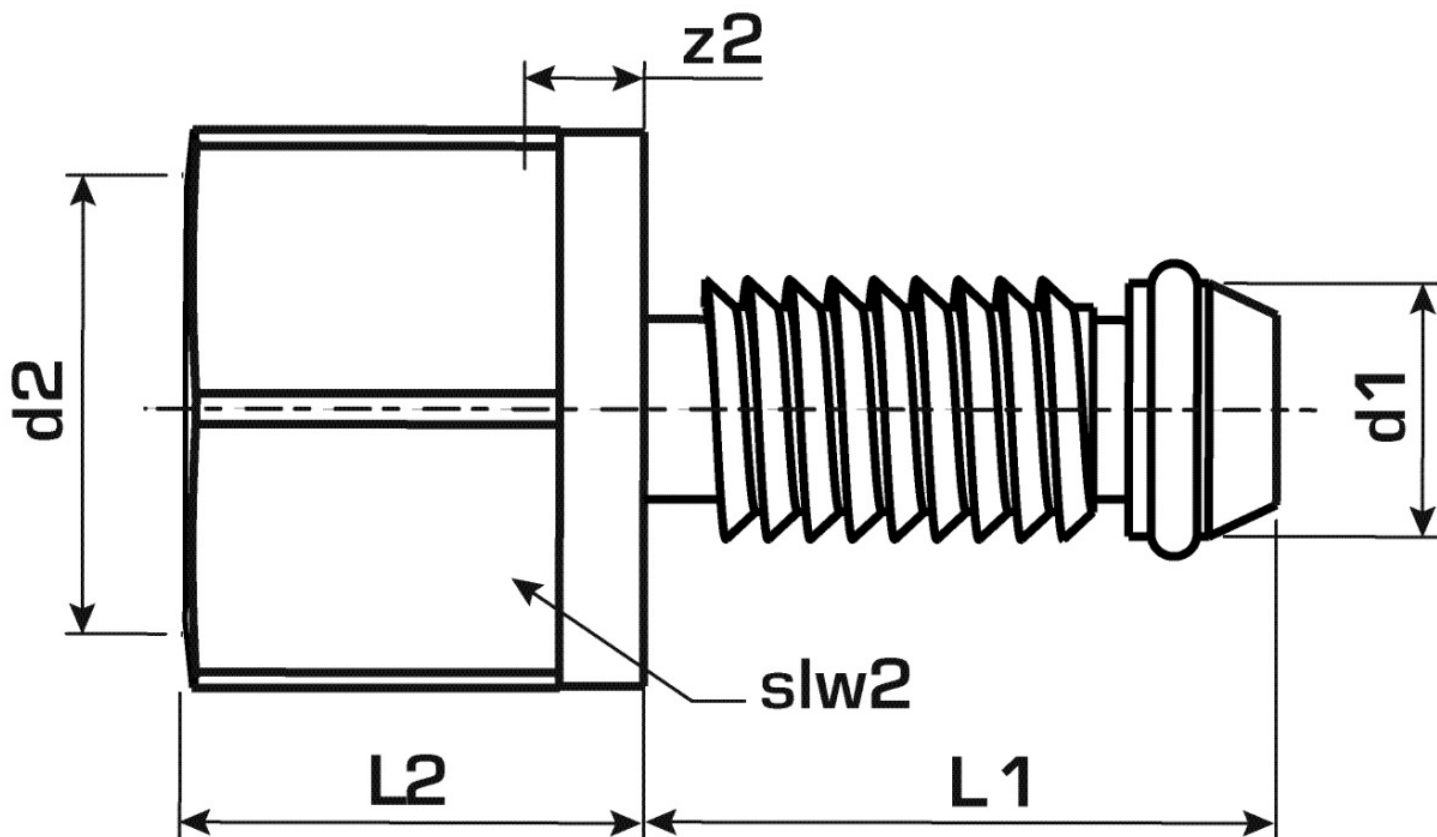

Art. No	label	d1 mm	L1 mm	L2 mm	z2 mm	slw2
7604160	16x1/2"	16	30	22	5	27