

# KELOX

## KM258 KELOX stopper for pressure testing O-Ring 20

7604201

### Areas of application

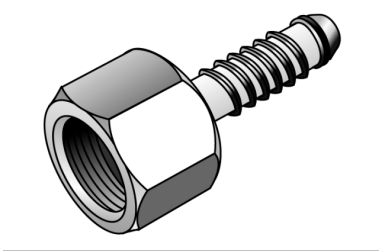

Re-usable plug for forcing off KELOX multilayer pipes

After removing the forcing-off plug, cut off the pipe end!

NOT suitable for continuous use!

# Specifications

## Technical properties

maximum working pressure at 20 ° C	10
------------------------------------	----

## Product information

VPE1	10,00 SA1
VPE2	1000,00 KT1
weight	0,002 KGM
text	KELOX stopper for pressure testing
INTRNR	40169300
main material group	KELOX
material group	KELOX accessories
code	KM258

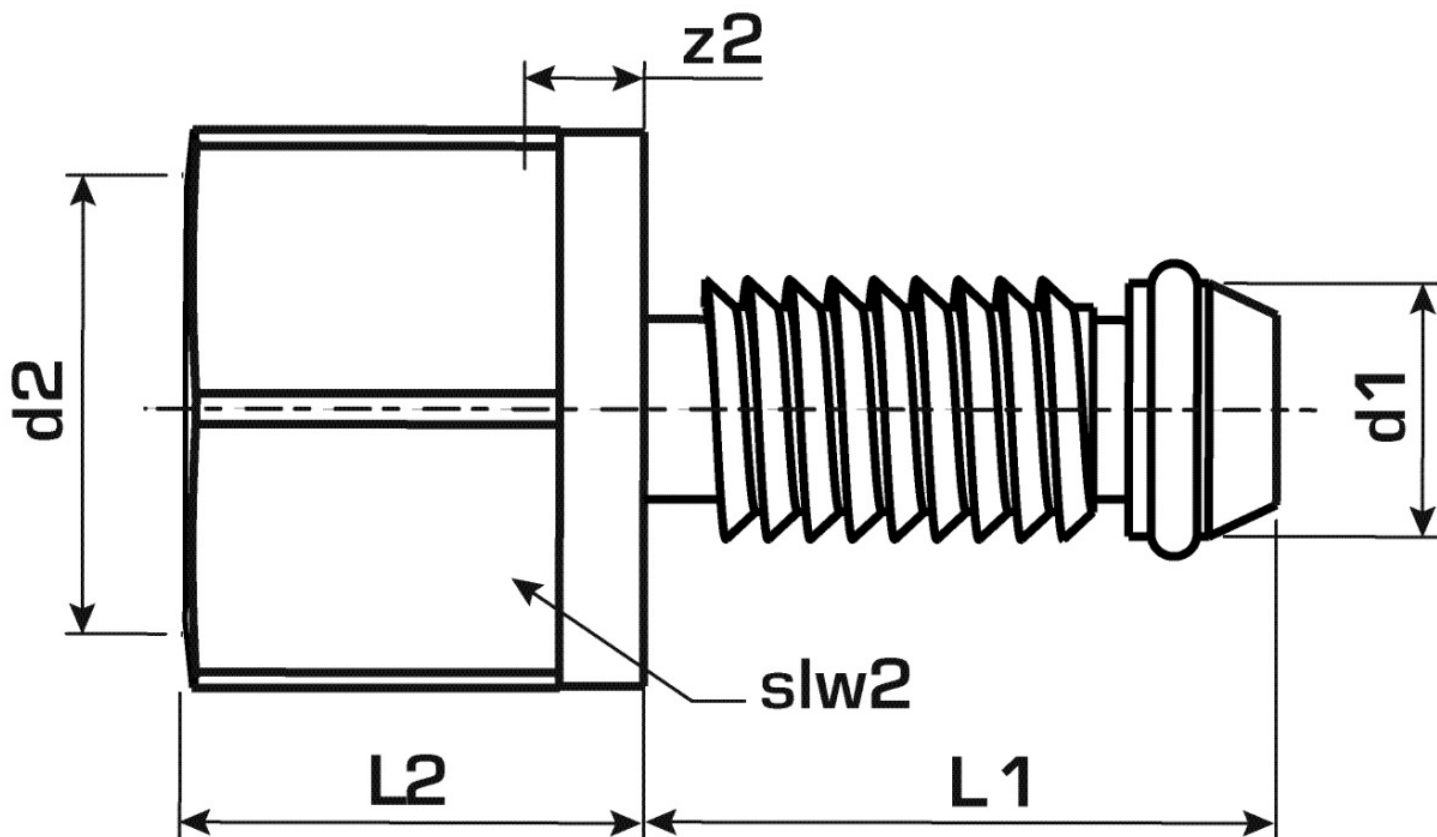

Art. No

label

7604201

O-Ring 20