

# KELOX

## KMU450 KELOX-ULTRAX adapter male 40x6/4"

71202G07

### Areas of application

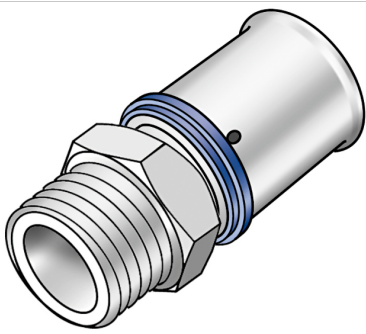

Press adapter with male thread for sealing, made of non-porous metallised brass, incl. support sleeves with O-rings and stainless steel press-fit sleeves, "leak before pressed"

### Approvals:



# Specifications

## Article information

port 1	Pressing socket
port 2	Male thread, conical (NPT)
execution	1-part
design	Straight
press contour	U

## Technical properties

maximum working pressure at 20 ° C	10 bar
------------------------------------	--------

## Product information

VPE1	1,00 SA1
VPE2	30,00 KT1
weight	0,394 KGM
text	KELOX-ULTRAX adapter male
INTRNR	74122000
main material group	KELOX
material group	KELOX-ULTRAX metal fittings
code	KMU450



Art. No	label	d2 Inches	d1 mm	L1 mm	L2 mm	z1 mm	slw1 mm	slw2 mm
71202G07	40x6/4"	1 1/2"	40	58	19	15	55	55