

STEELOX

SMX455 ?STEELOX union with female thread
16x1/2"

57203B02

Areas of application

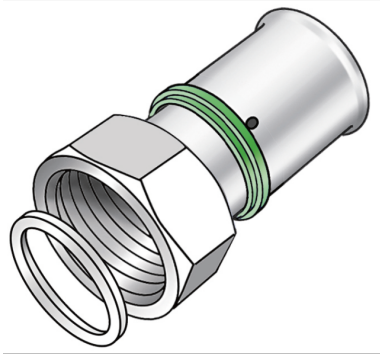

?Press-fit union with female thread for connection to fittings and devices such as filters, manifolds, pumps,..... made of dezincification-resistant (DZR) non-porous metallised brass, incl. support sleeves with O-rings and stainless steel pressing sleeves, "leak before pressed"

Approvals:



KE KELIT GmbH

A 4020 Linz, Ignaz-Mayer-Straße 17, Austria, Europe

PHONE +43 (0) 50 779 E-MAIL office@kekelit.com

www.kekelit.com

Specifications

Article information

port 1	Pressing socket
port 2	Union nut
execution	2-part
design	Straight
press contour	SX

Technical properties

maximum working pressure at 20 ° C	10 bar
------------------------------------	--------

Product information

VPE1	10,00 SA1
VPE2	200,00 KT1
weight	0,056 KGM
text	?STEELOX union with female thread
INTRNR	74122000
code	SMX455



Art. No	label	d2 Inches	d1 mm	L1 mm	L2 mm	z1 mm	z2 mm	slw1 mm	slw2 mm
57203B02	16x1/2"	1/2" (15)	16	37	10	13	4	24	24